

$$3 - 2 = \square$$

$$3 - 0 = \square$$

$$3 - 1 = \square$$

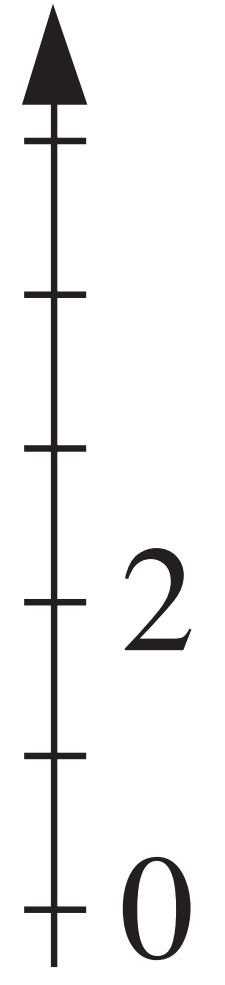

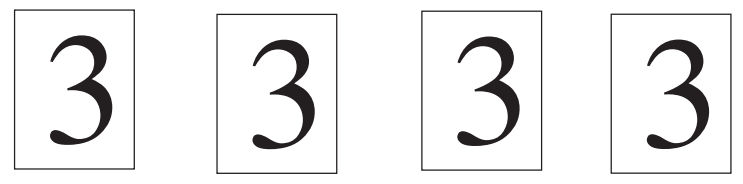
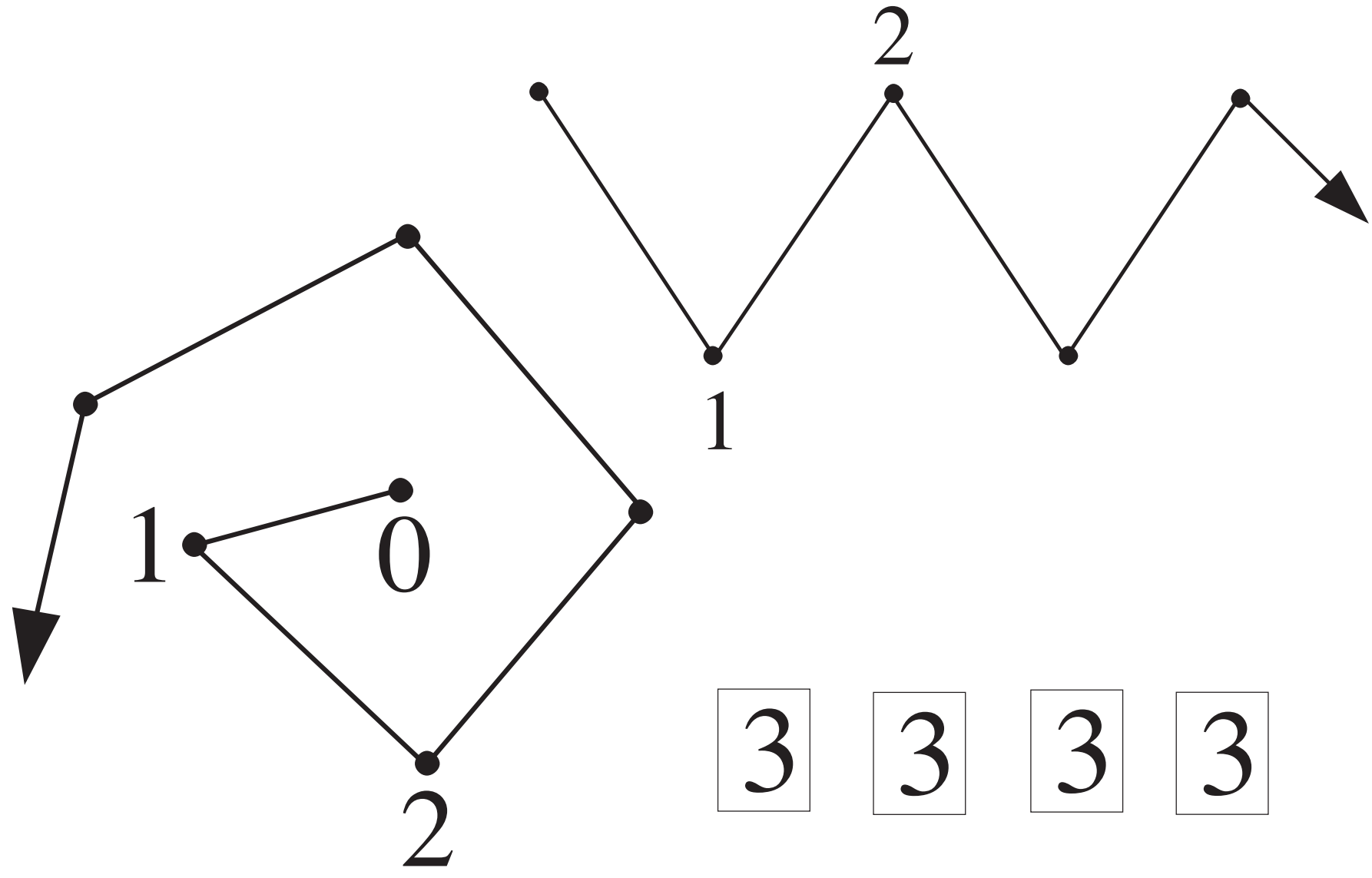
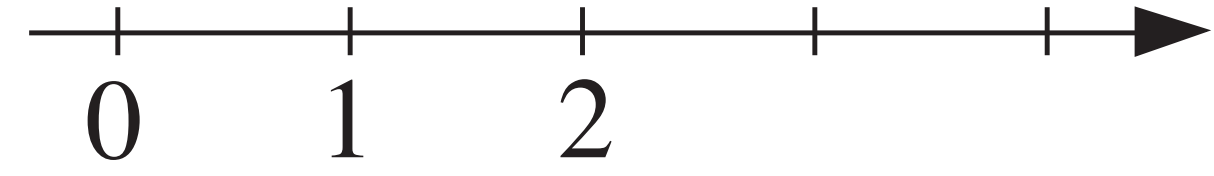
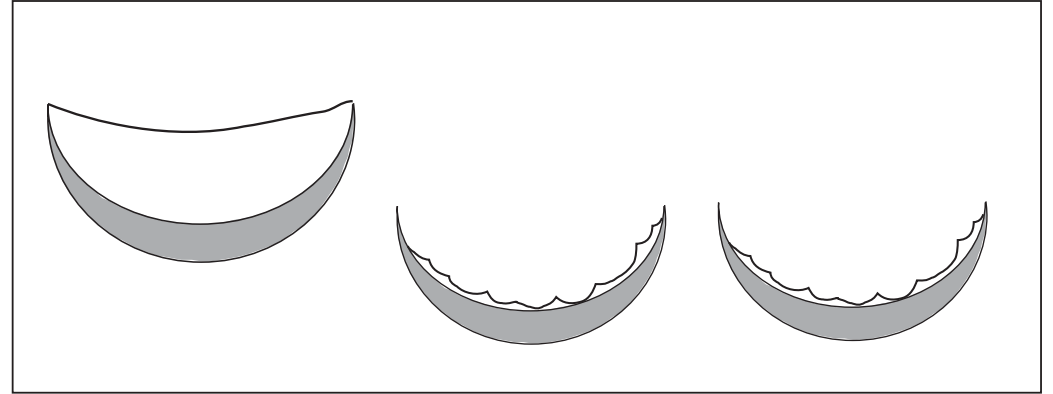
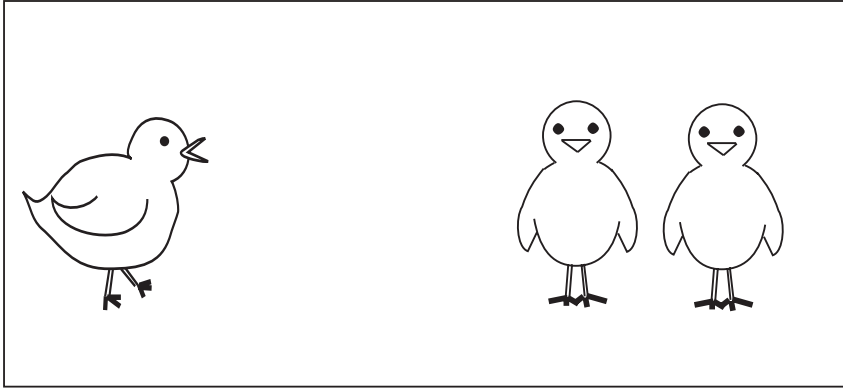

3	=		+	2
---	---	--	---	---

3	-		=	1
---	---	--	---	---

LP 28/1

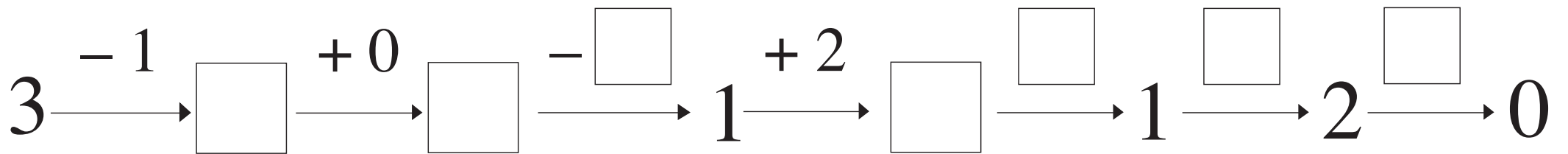

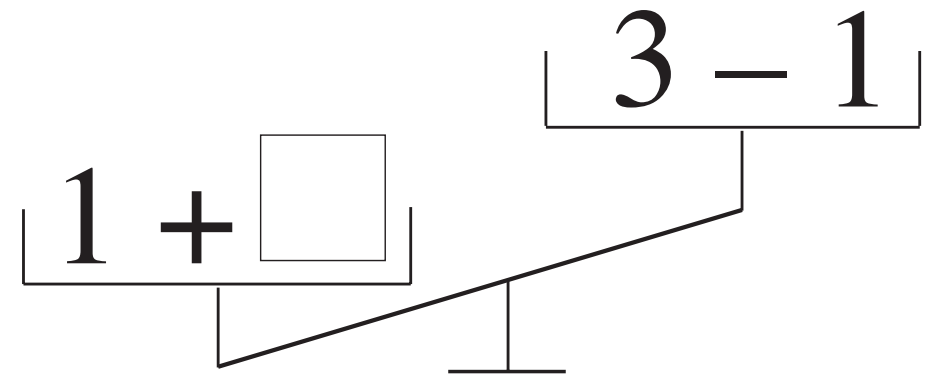
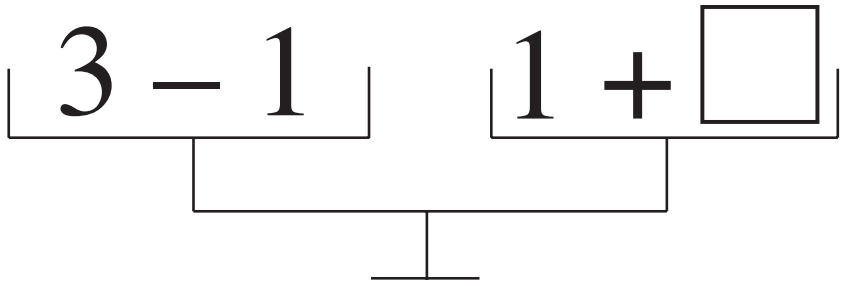

$$\square =$$

$$\square :$$

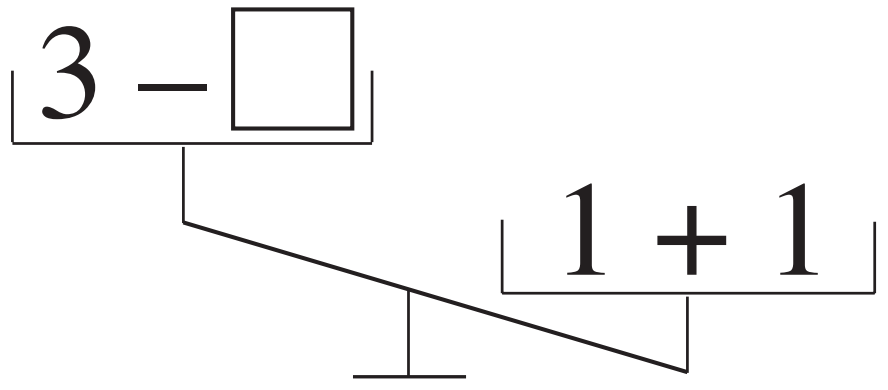

$$\square :$$

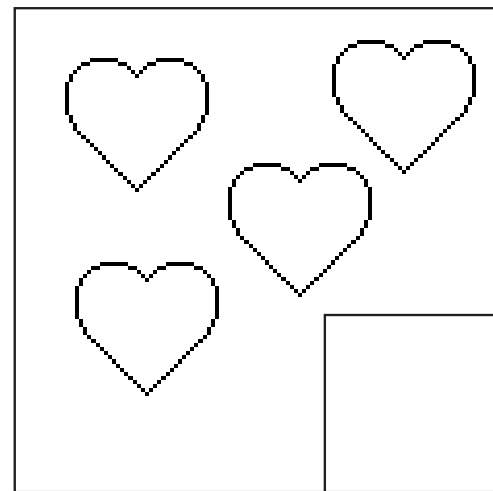
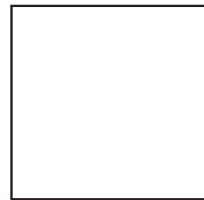
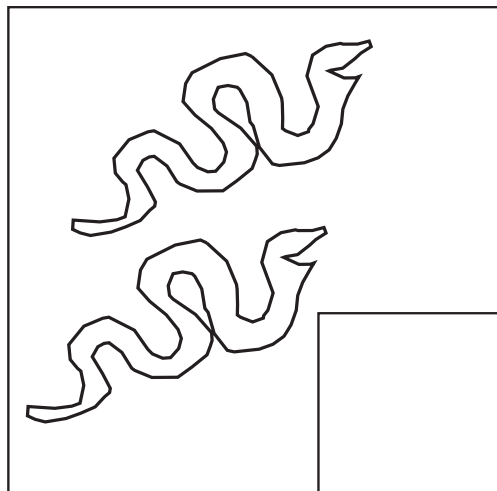
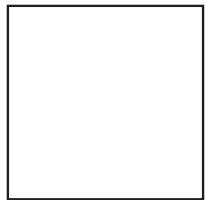
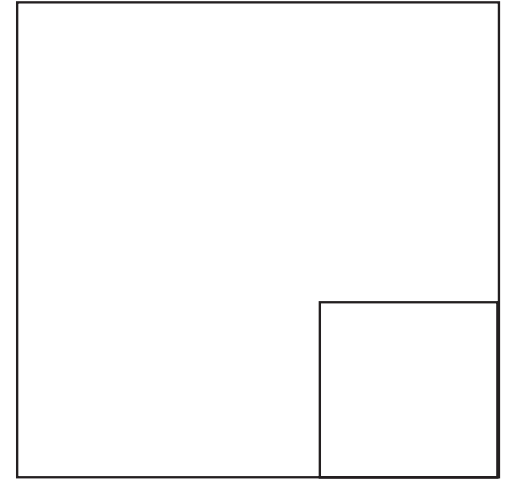
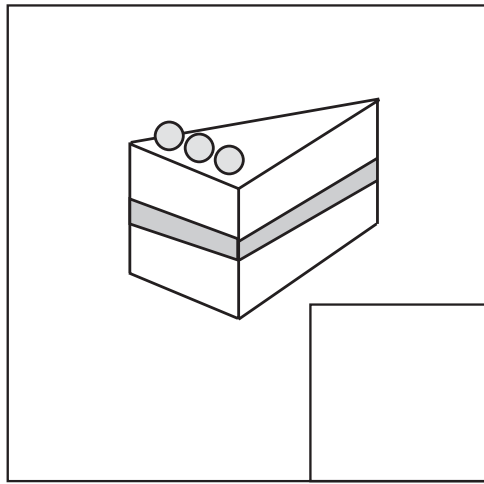
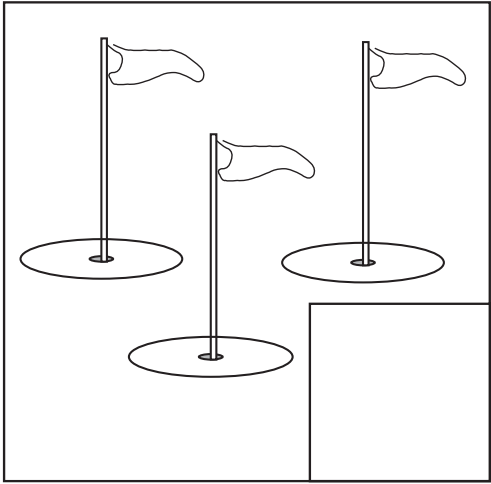
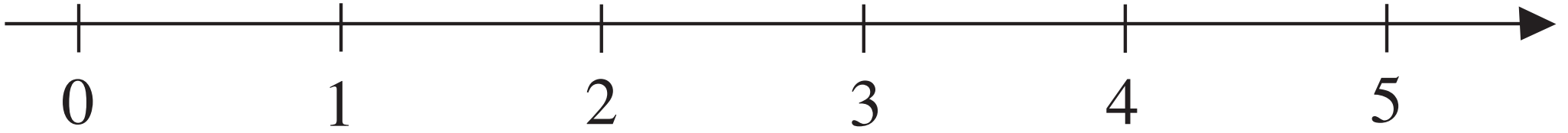

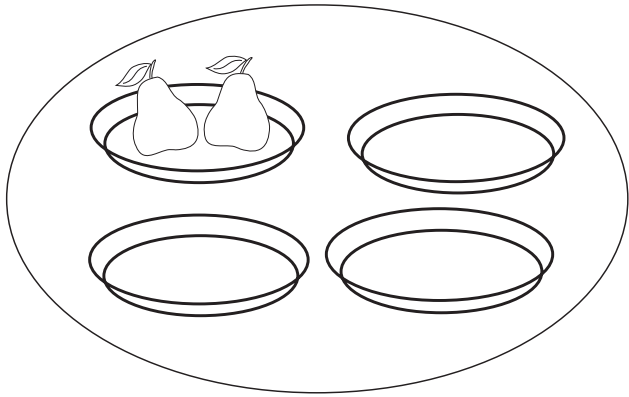

4	-	3	=	
---	---	---	---	--

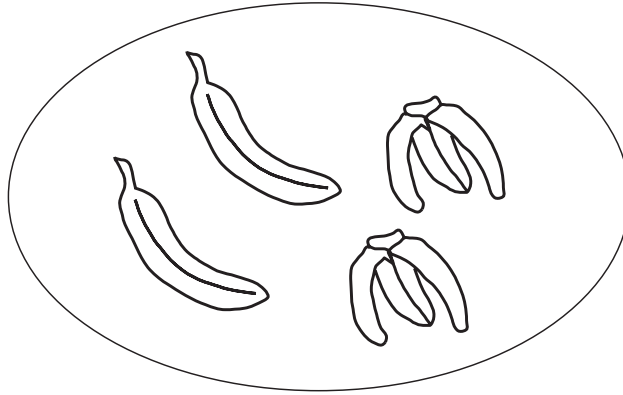

	-		=	
--	---	--	---	--

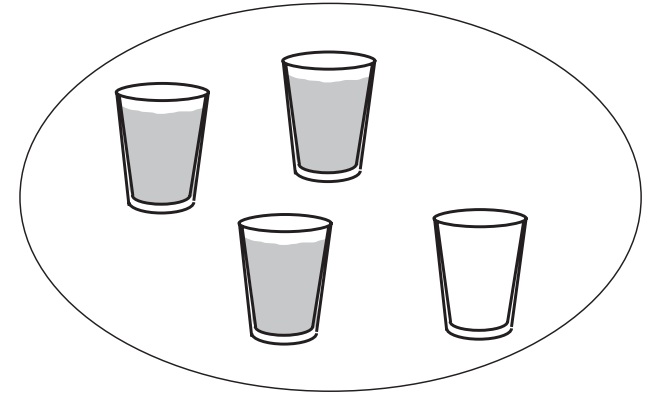

			=	
--	--	--	---	--

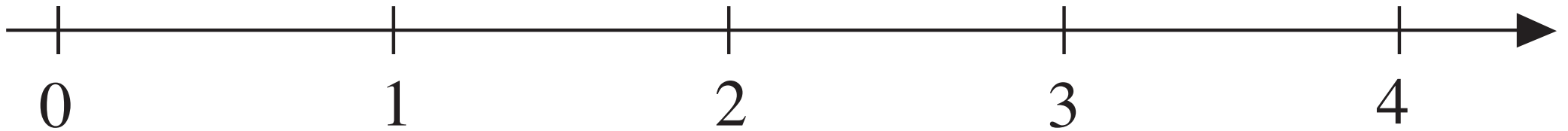

4	=	1	+	

4	=		+	3

4	=		+	2

LP31/6

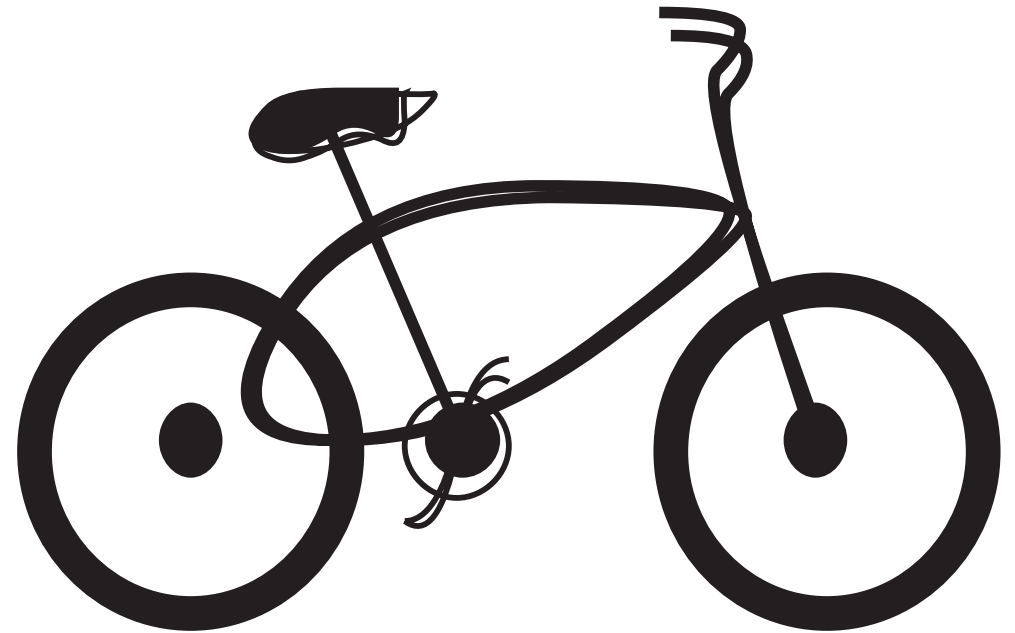
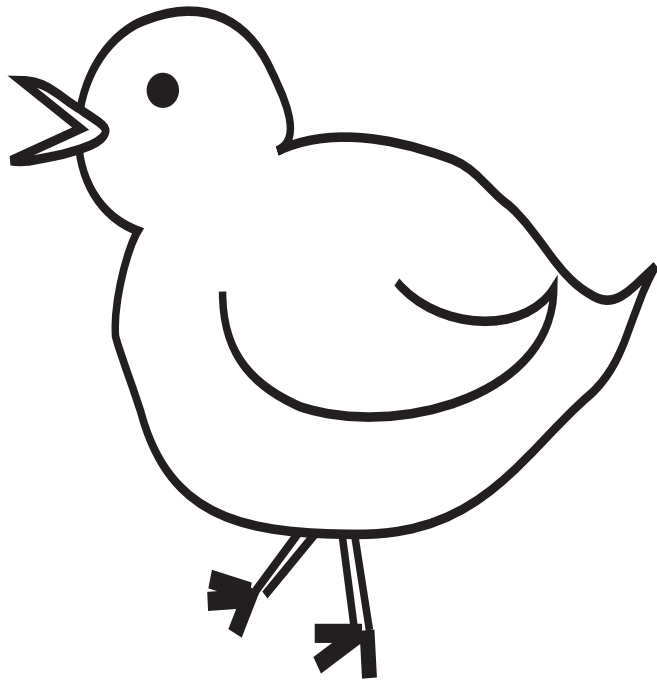

Or use for practice with ordinal and cardinal numbers

LP32/1



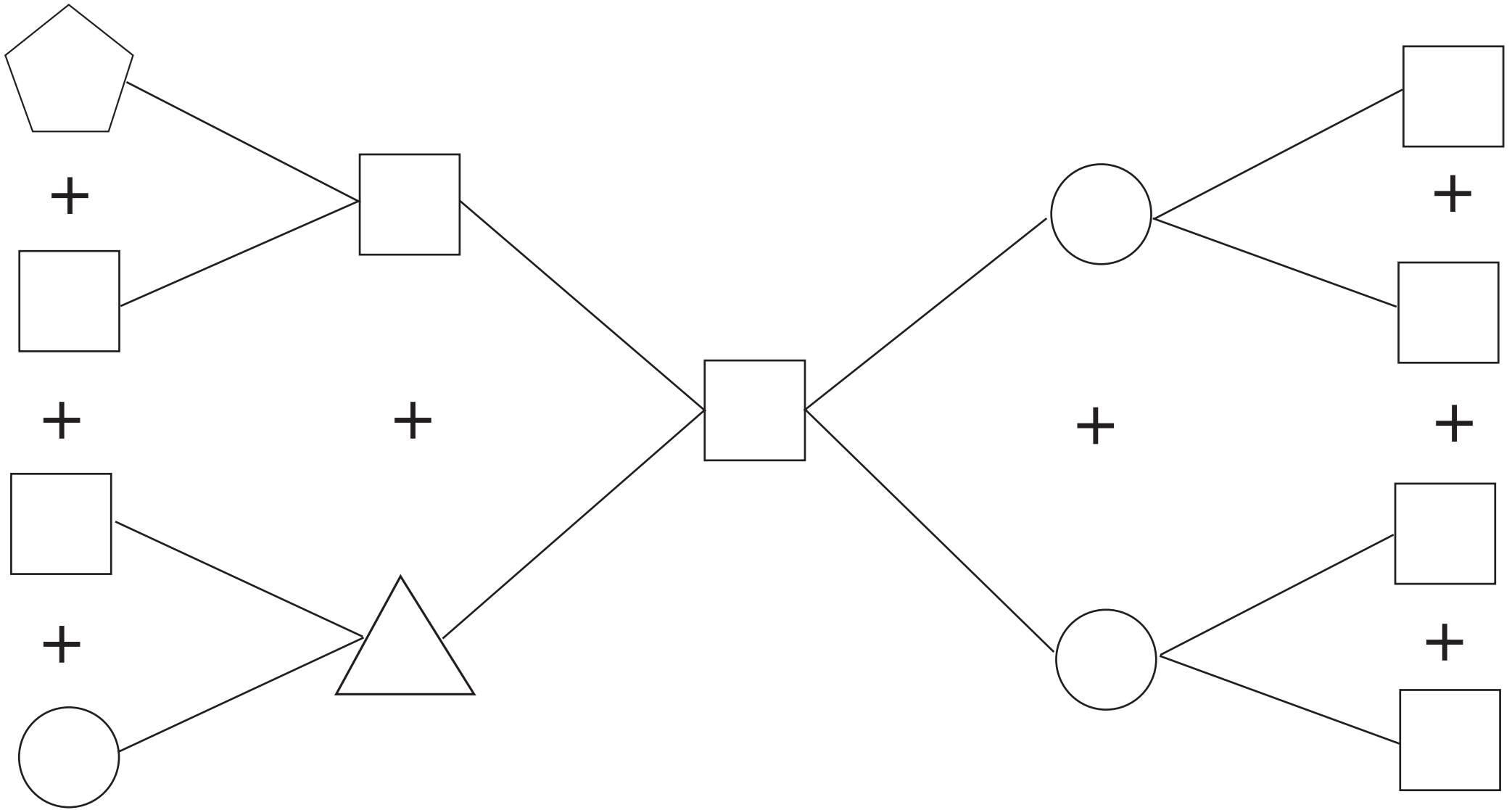

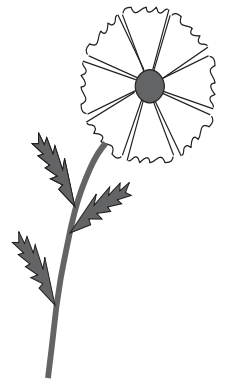
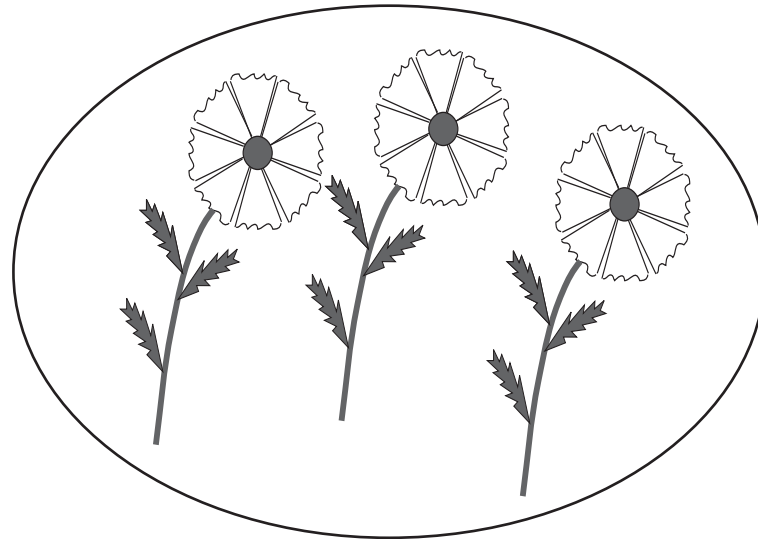
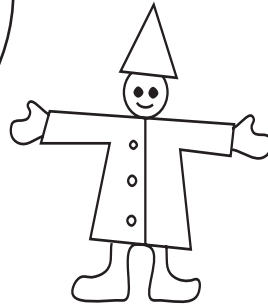
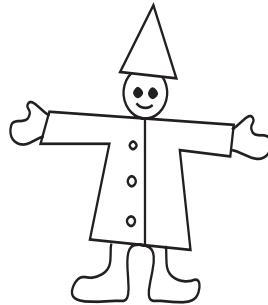
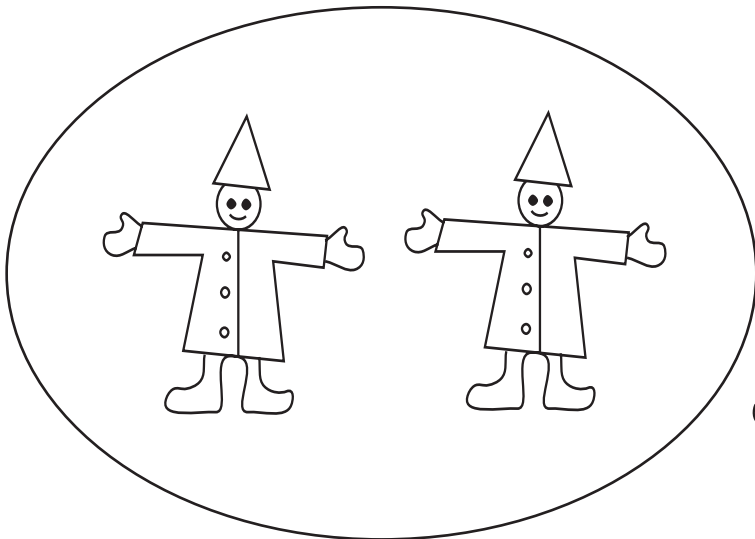
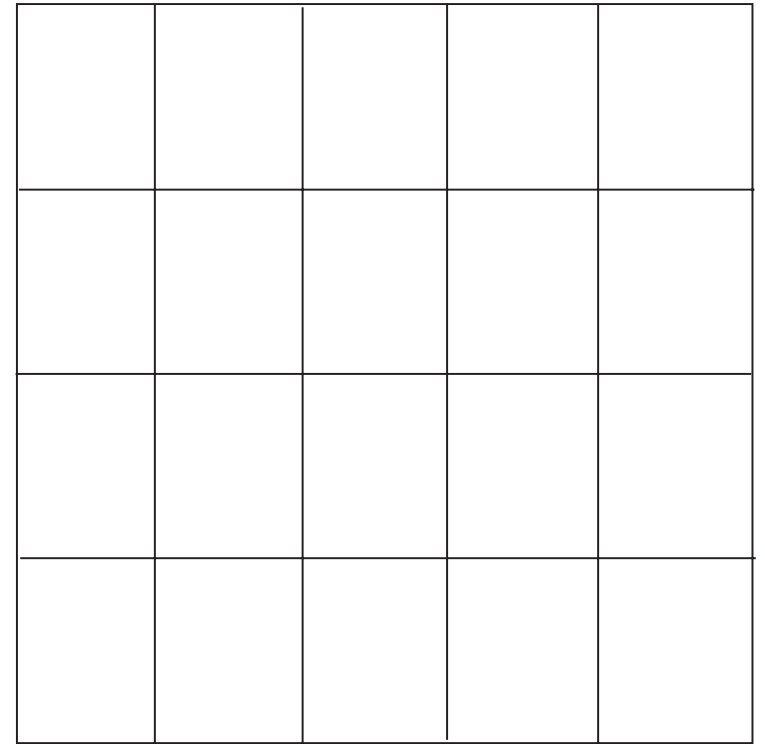
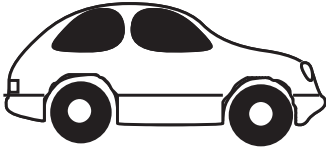
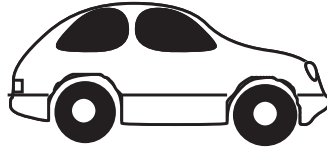
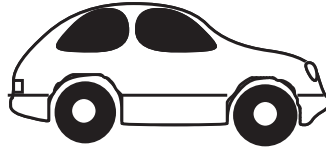
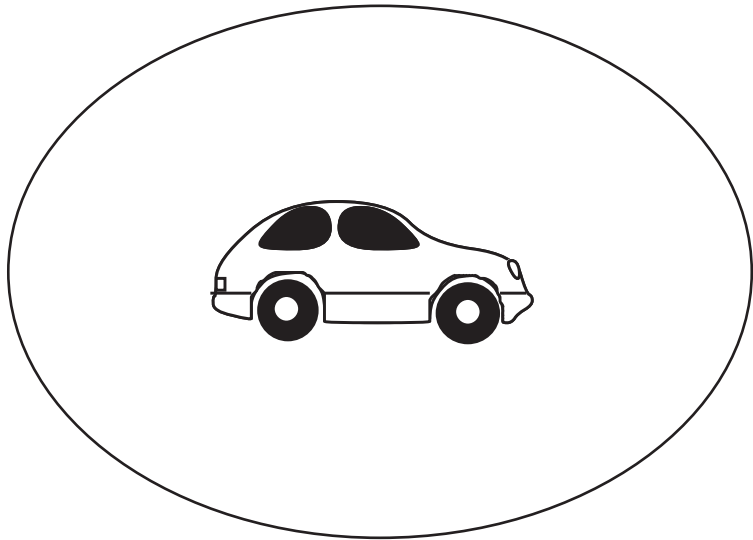

A								
B								
A+B								

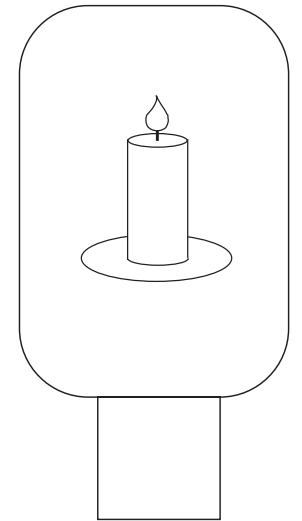
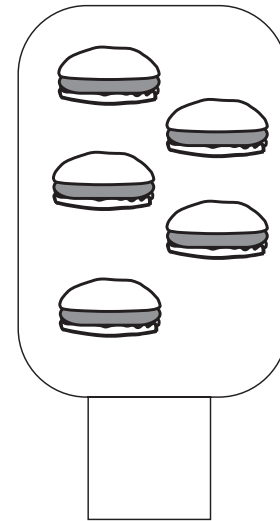
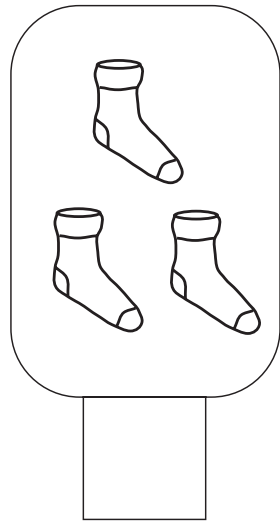
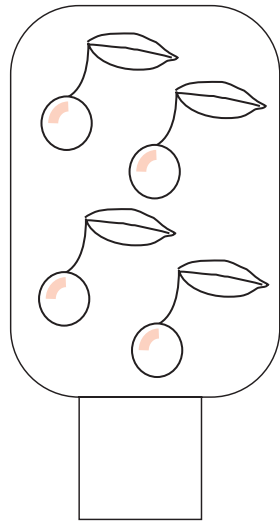
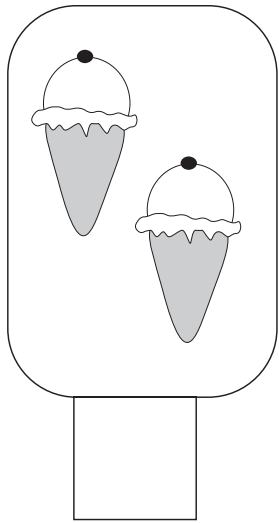
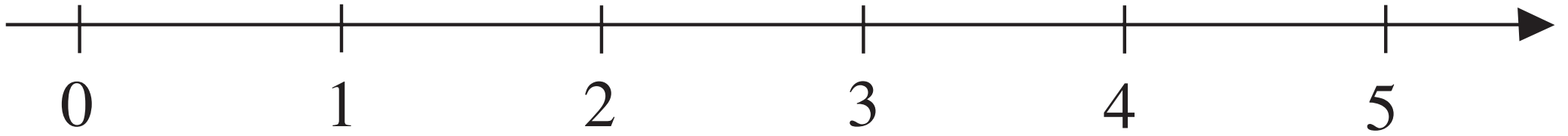

5	-	3	=	

	-		=	

			=	

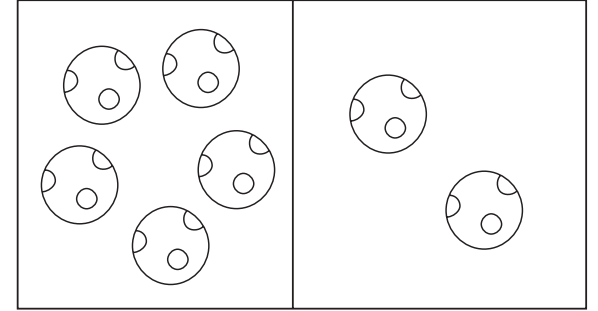
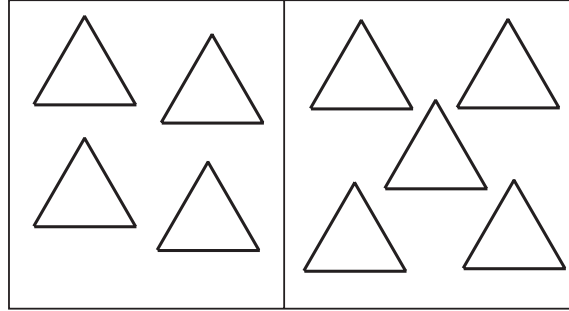
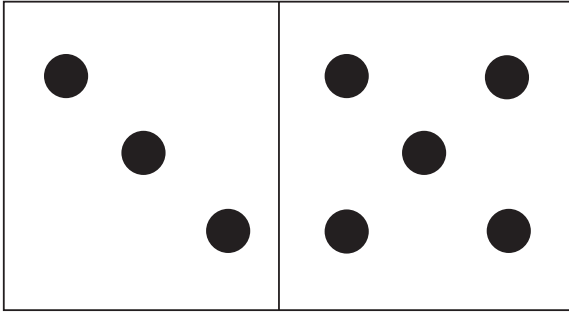

3	$\triangleleft_2$	5		
5	$\triangleright_2$	3		
3	+		=	5
5	-		=	





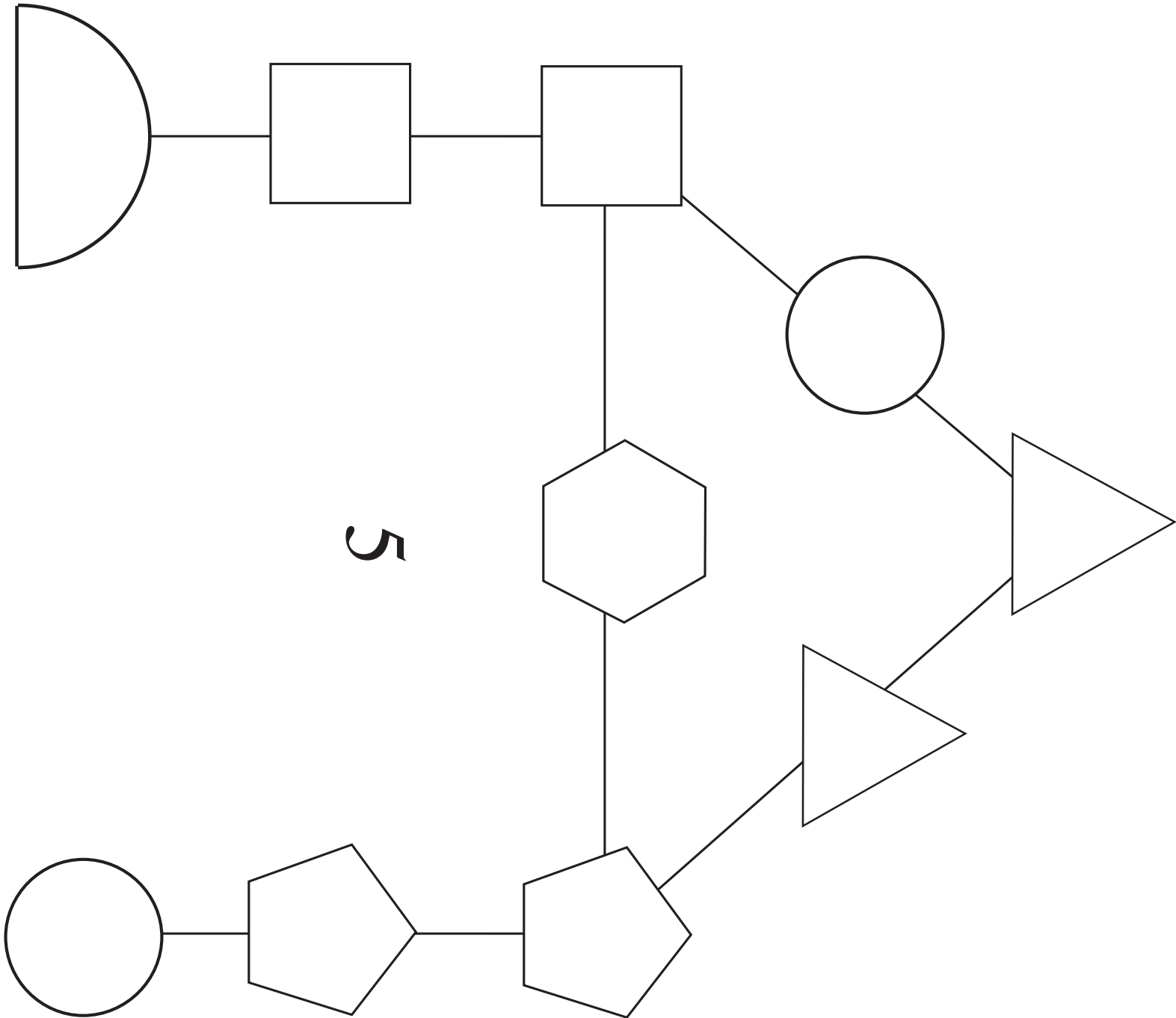

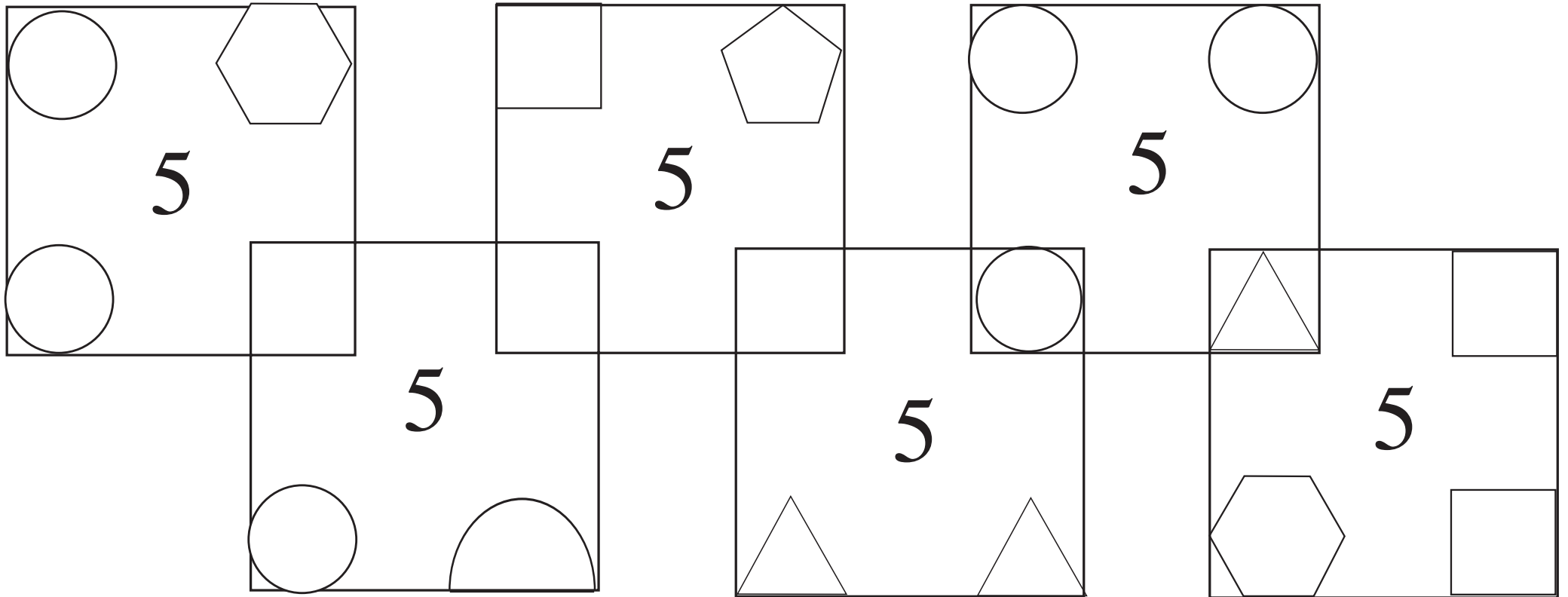

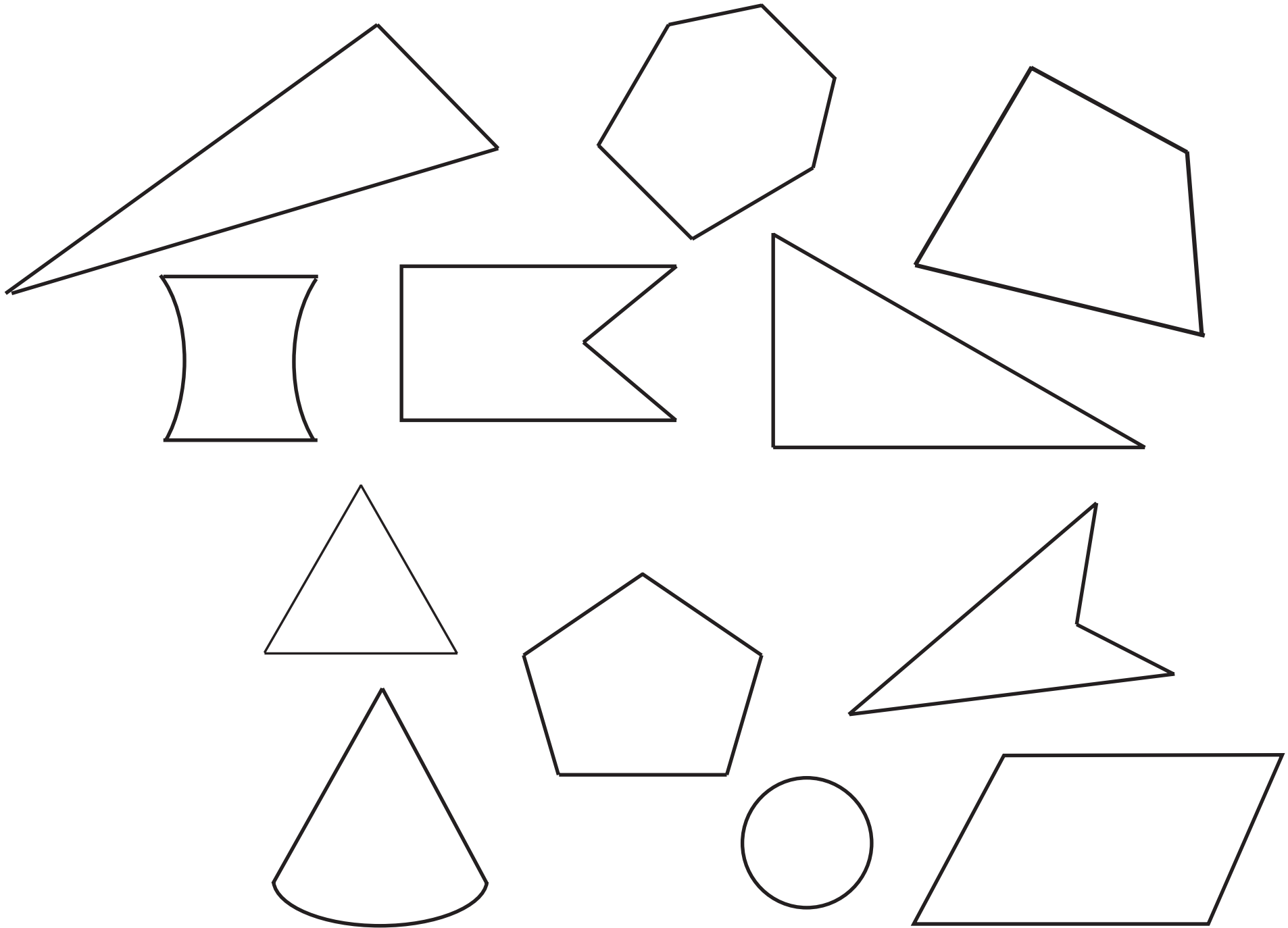

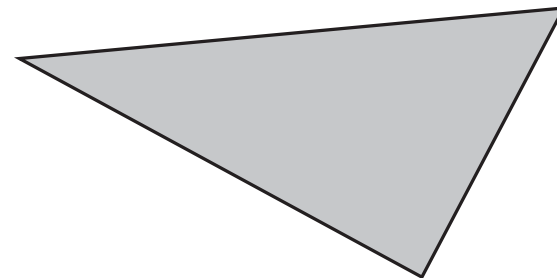
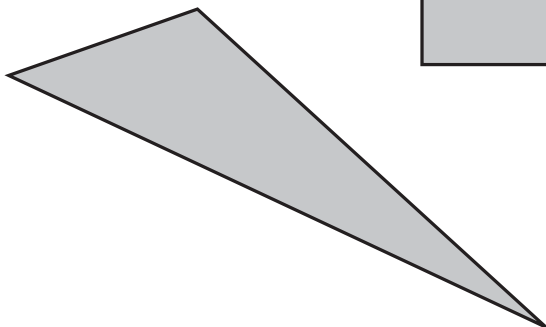
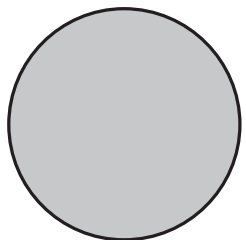
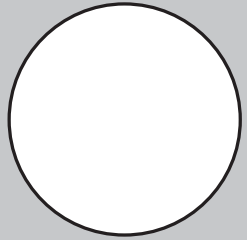
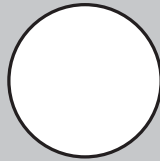
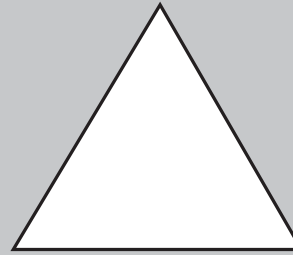
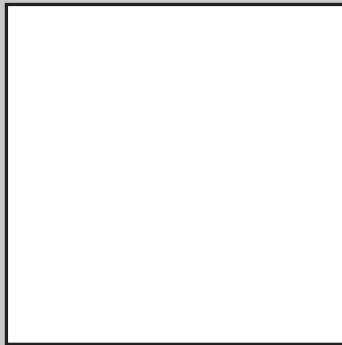
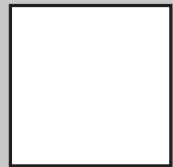
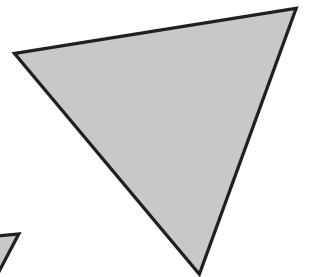
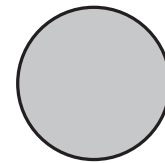
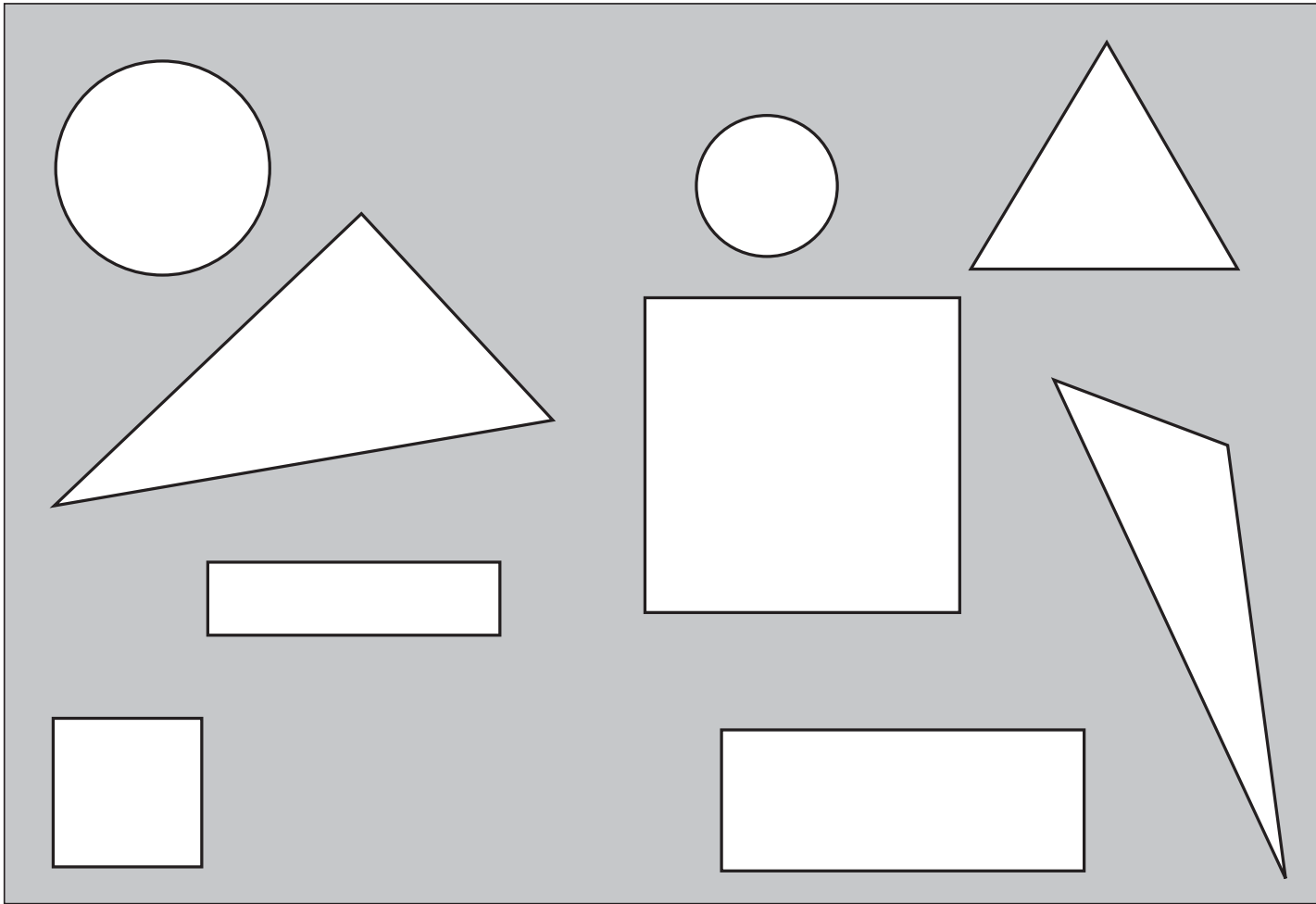

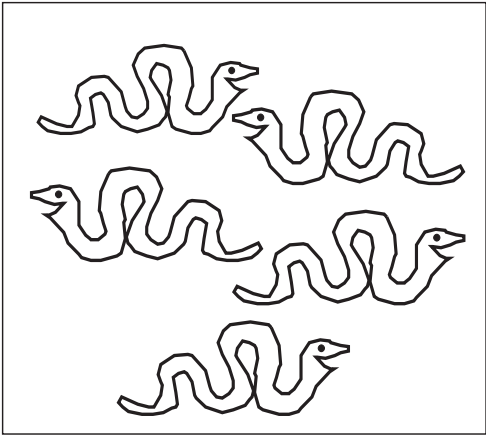

1 < 2

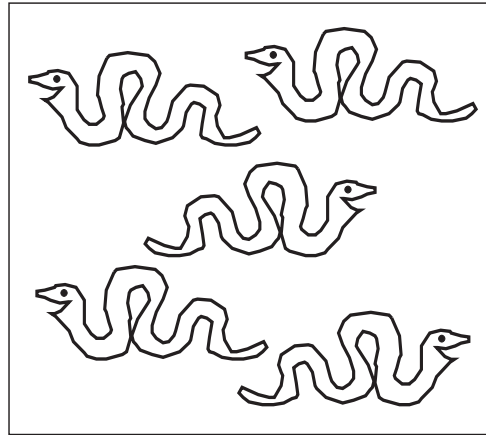

5 > 2

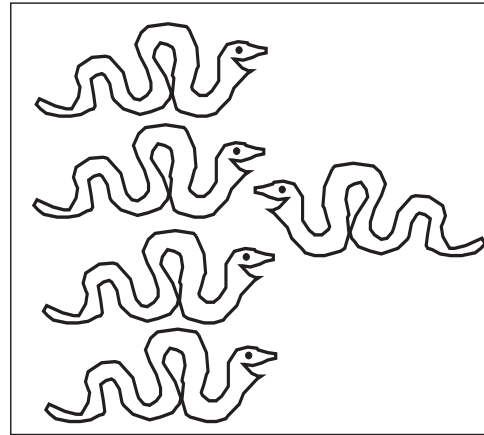

> 2

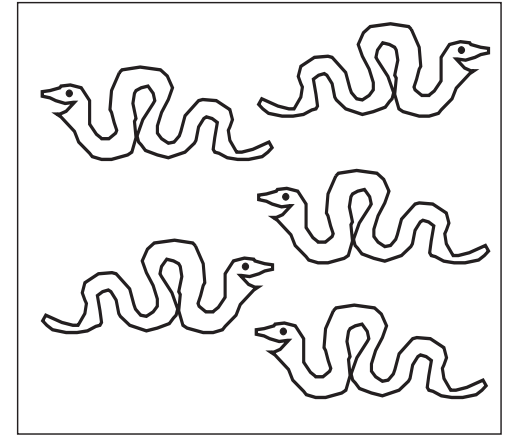

< 3 4

$$4 = \boxed{\times}$$



$$\boxed{\times} < 4$$

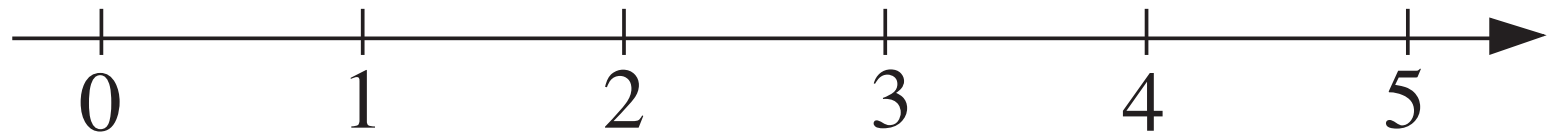

$$3 < \boxed{\times}$$

