

# 1 litre

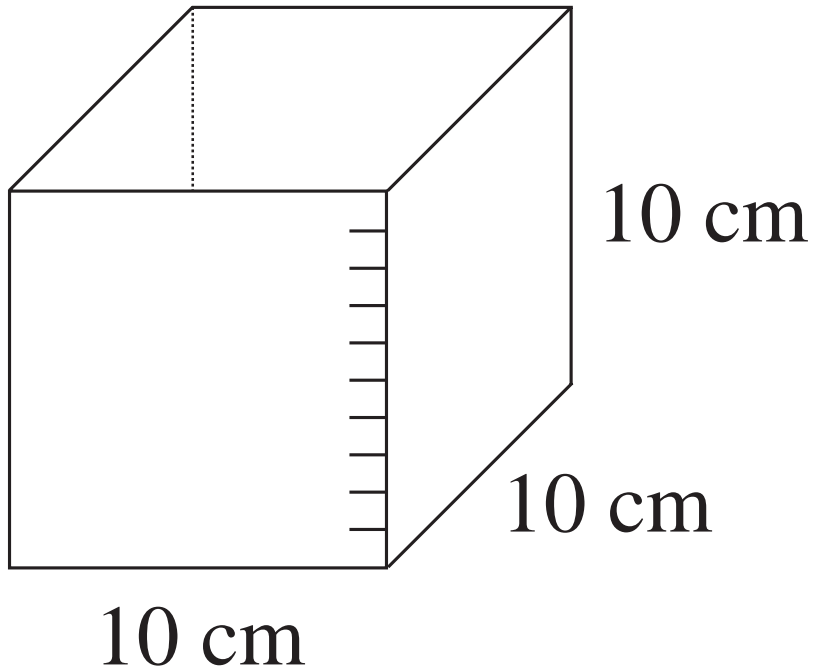

# 10 cl

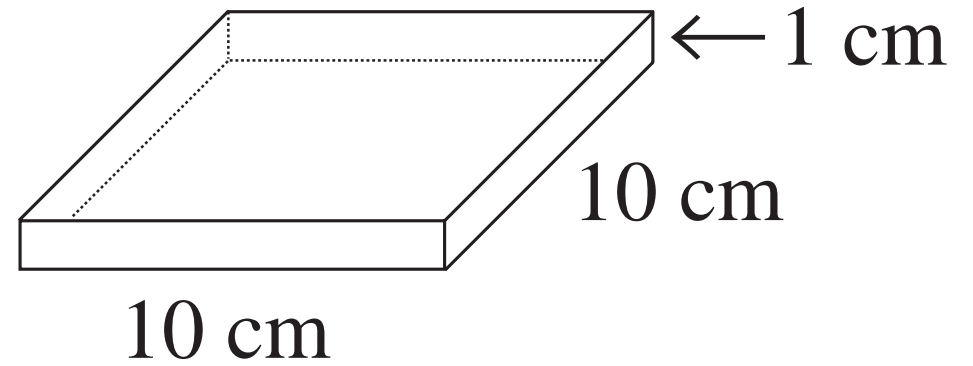

# 1 cl

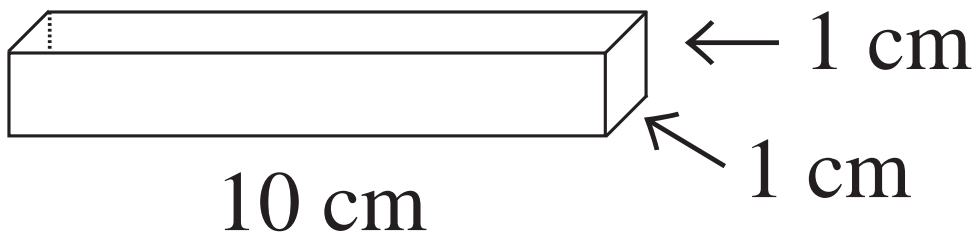

# 1 ml

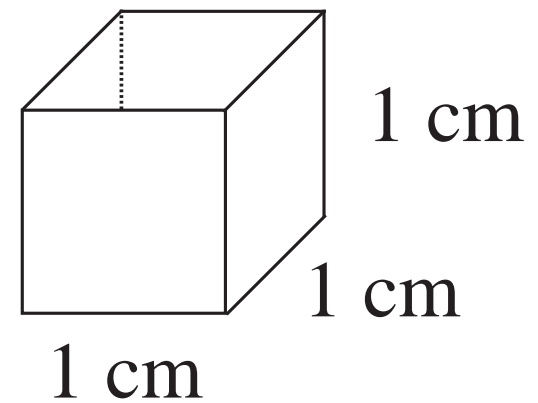

<i>S</i>	1 litre			70 ml		115 cl		
<i>J</i>		1 and a half litres	70 cl		830 ml		1400 ml	200 cl

$S =$

$J =$

$S + J =$

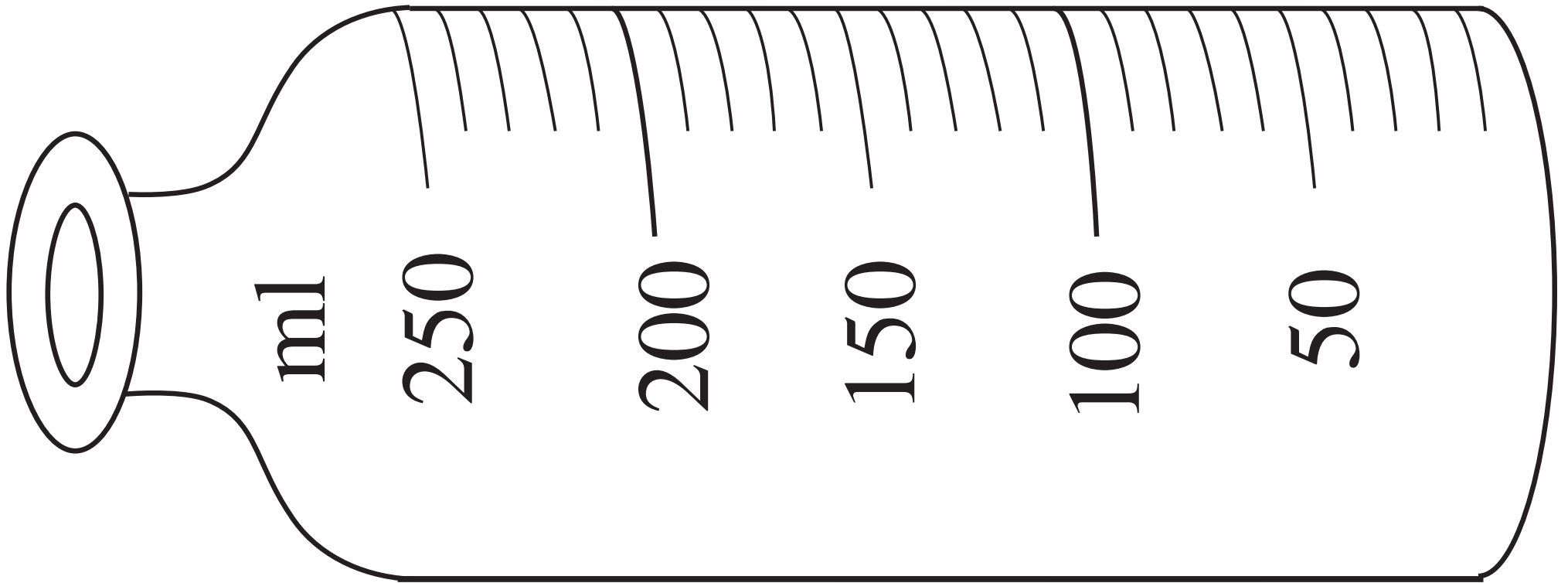

LP 81/7

ml	1200	2000	800				1850
cl	120					190	
10 cl	12				15		
litres	1 and 2 tenths			1 and 23 hundredths			

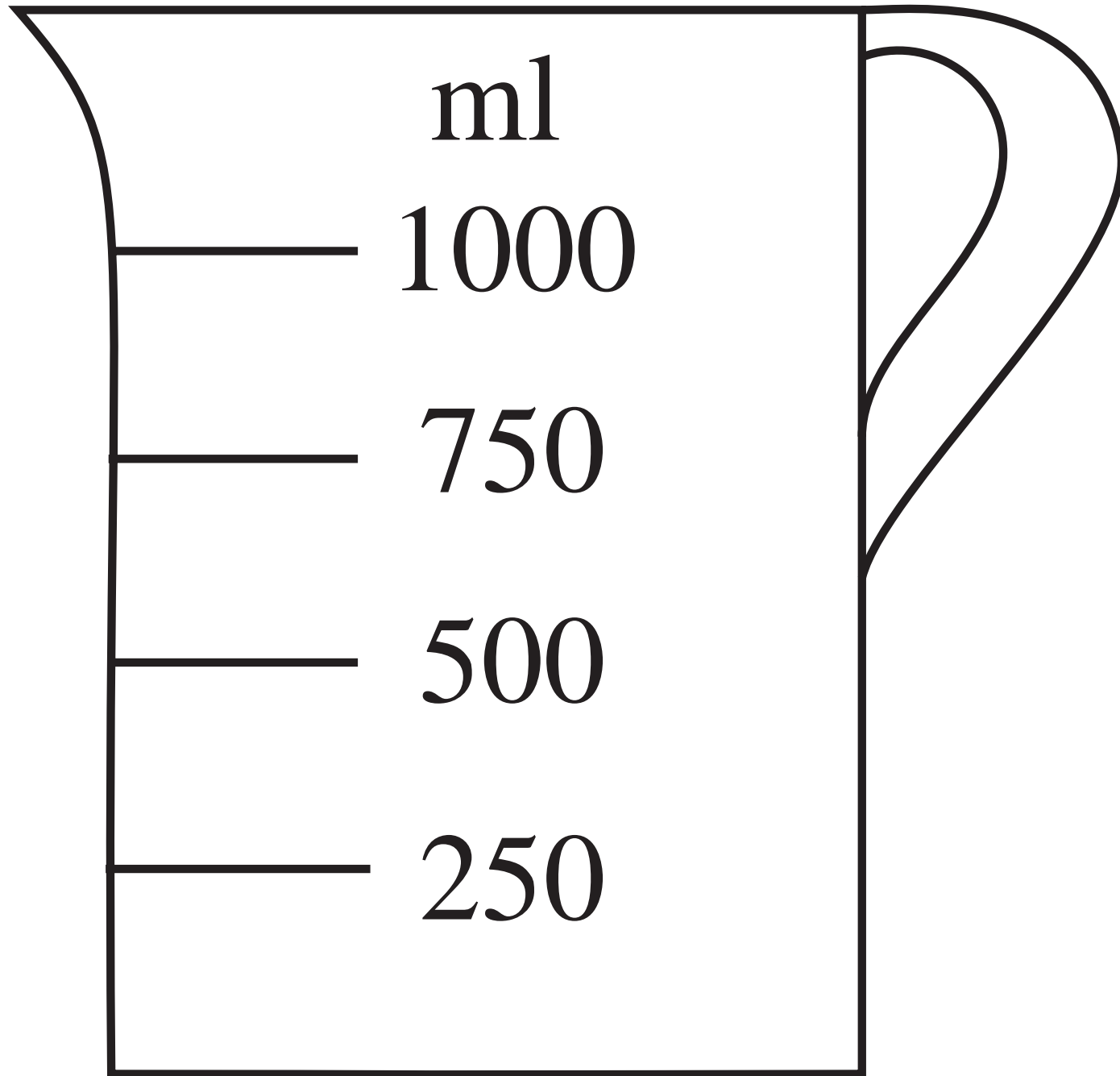

h						
t						
U						
T						
H						

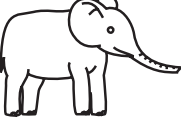

	35 litres			1350 cl			41.3 litres
		47 litres	29 and a half litres		28 litres 20 cl	19 and 3 tenths litres	

 $E =$ 
 $R =$ 
 $4 \text{ litres} =$ 

LP 82/8

<i>A</i>	36 ml	23 cl	1214 <i>l</i>	141 ml	716 cl	325 <i>l</i>	996 ml	102 cl	450 <i>l</i>
<i>B</i>	40 ml	20 cl	1210 <i>l</i>						

LP 82/9



Th	H	T	U	t	h	th

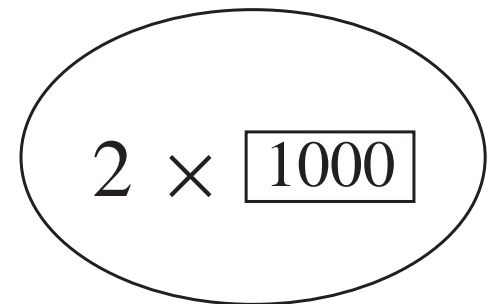
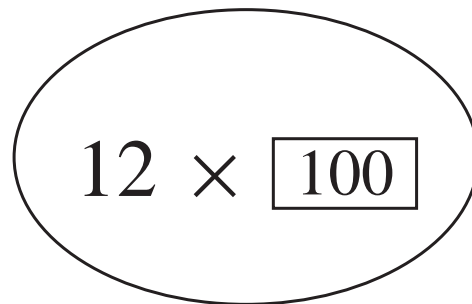
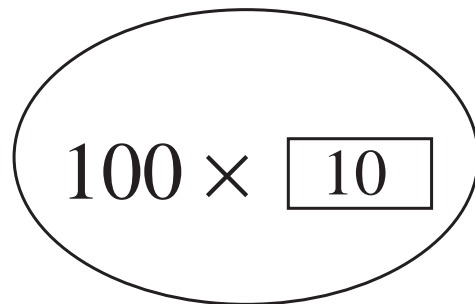
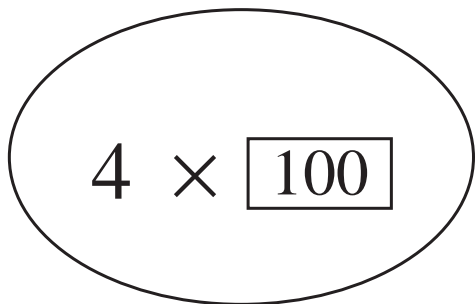
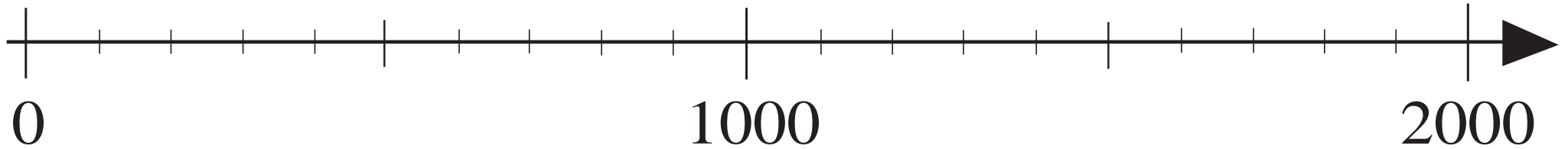
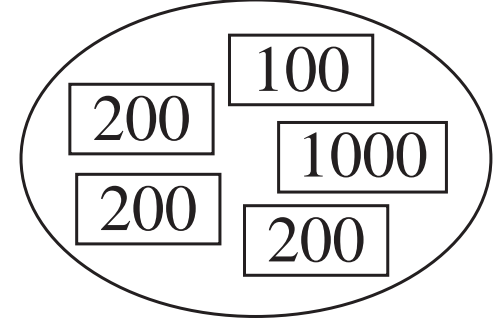
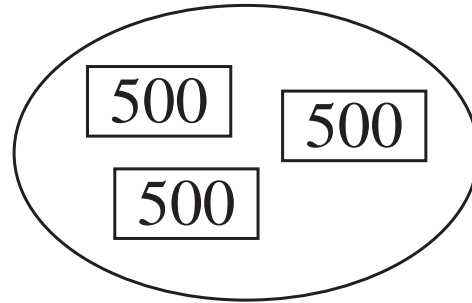
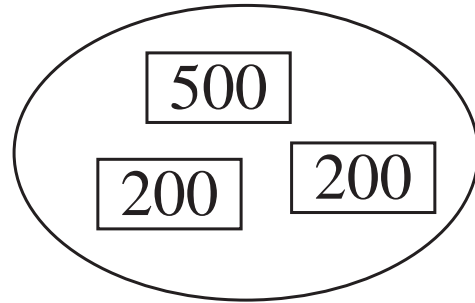
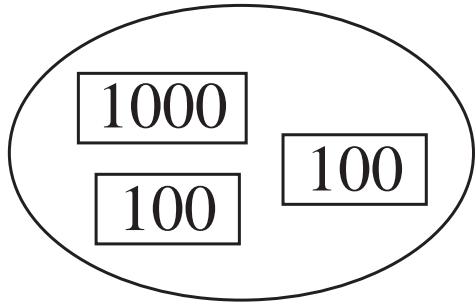



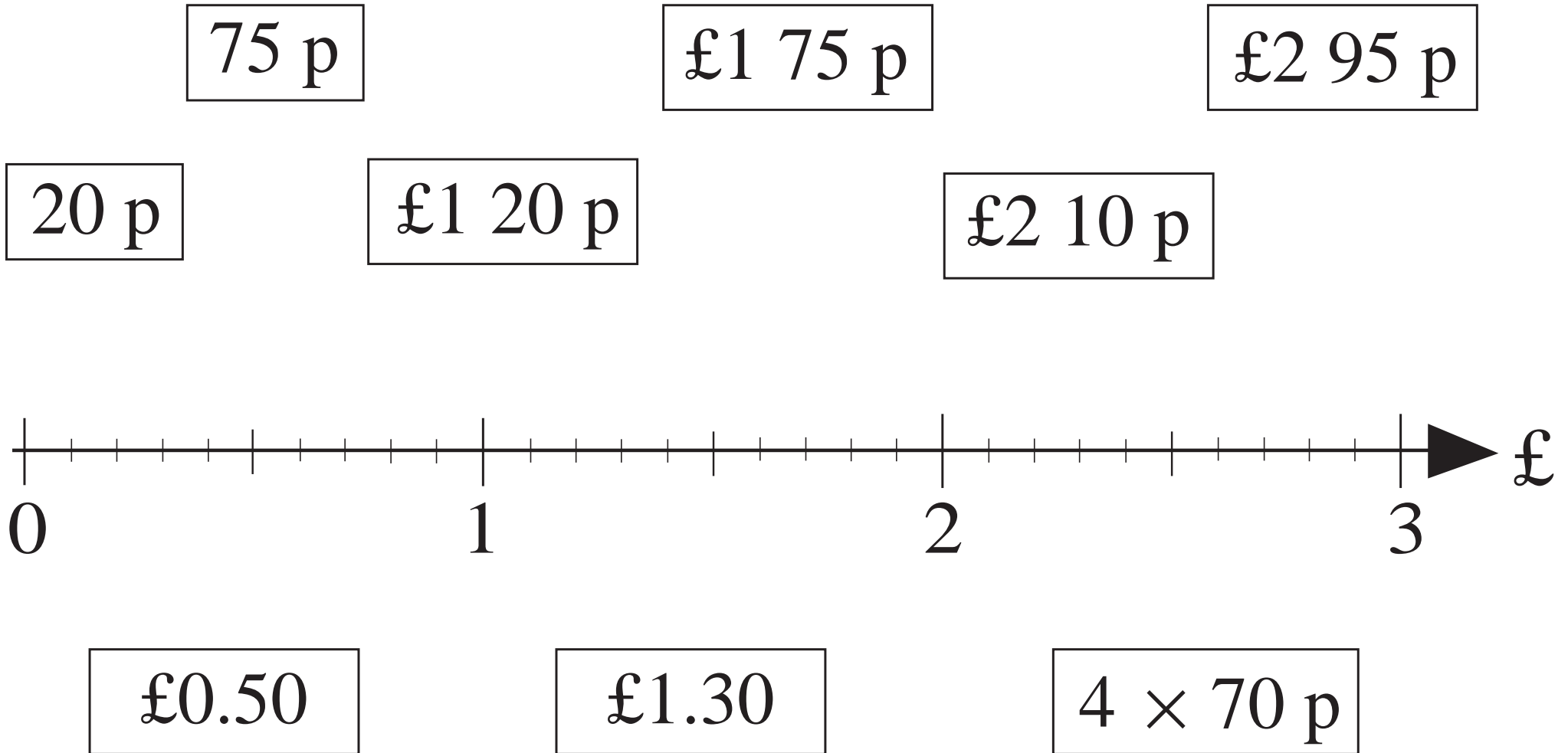

a)

£1 10p  
 £1 10p  
 £1 10p 1p  
 £1 10p 1p

□ □ □ p

b)

£1  
 £1  
 £1 1p  
 £10 £1 1p

□ □ □ □ p

c)

1p  
 1p  
 10p 1p  
 10p 1p  
 £10 10p 1p

□ □ □ □ p

LP 83/6

A	100 cm		300 cm		500 cm		0 cm		700 cm
B		1000 cm		1400 cm		1900 cm		2000 cm	

LP 84/7

a)  p

b)  p

b)  p

b)  p

c)  p

c)  p

d)  p

d)  p

a)

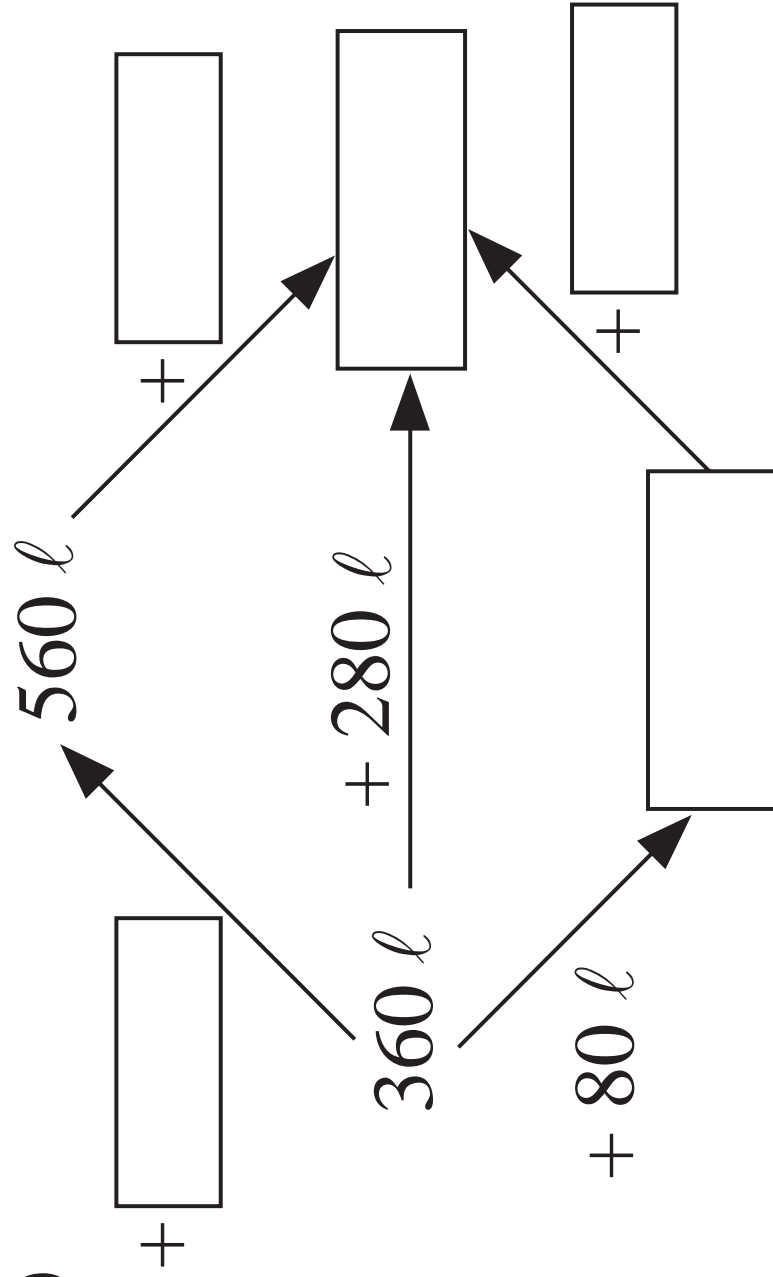

b)

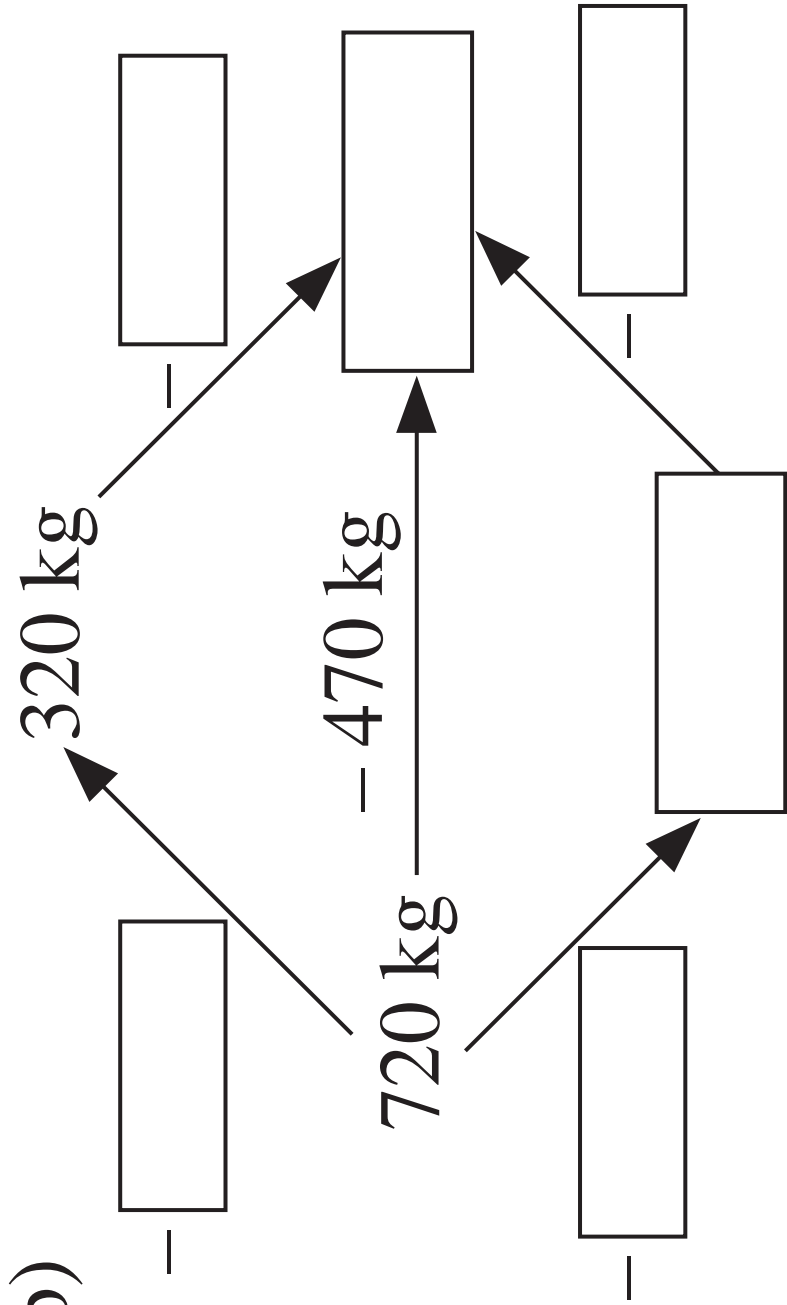

a)  $300 \text{ cl} + 400 \text{ cl}$

$300 \text{ cl} + 500 \text{ cl}$

b)  $600 \text{ g} + 700 \text{ g}$

$500 \text{ g} + 700 \text{ g}$

c)  $400 \text{ m} + 800 \text{ m}$

$500 \text{ m} + 700 \text{ m}$

d)  $900 \text{ ml} - 500 \text{ m}$

$900 \text{ ml} - 600 \text{ ml}$

e)  $1300 \text{ cm} - 600 \text{ cm}$

$1400 \text{ cm} - 700 \text{ cm}$

f)  $1500 \text{ l} - 800 \text{ l}$

$1400 \text{ l} - 900 \text{ l}$

a)  $260 \text{ cm} + 350 \text{ cm} = 360 \text{ cm} +$

b)  $190 \text{ g} + 470 \text{ g} =$    $+ 180 \text{ g}$

c)  $470 \text{ ml} + 280 \text{ ml} = 480 \text{ ml} +$

d)  $260 \text{ m} + 340 \text{ m} =$    $+ 169 \text{ m}$

e)  $750 \text{ l} - 160 \text{ l} = 740 \text{ l} -$

f)  $630 \text{ mm} - 470 \text{ mm} =$    $- 480 \text{ mm}$

0	11	20	37	44	59	62
73	88	95	100	111	126	135
142	157	160	173	184	191	200

LP 86/6

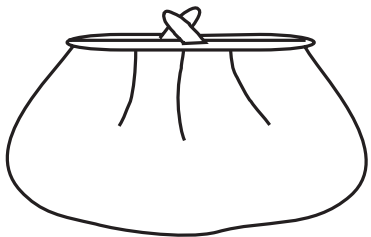

£5 73 p

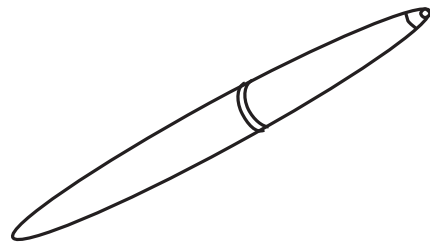

£4 58 p

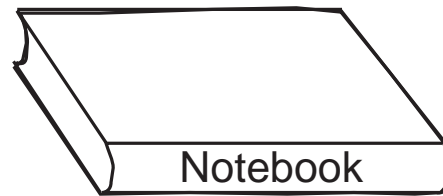

£3 12 p

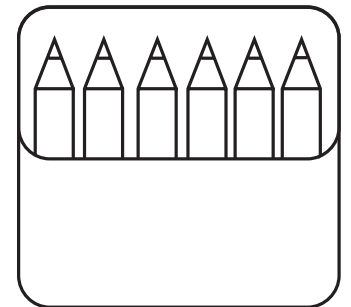

£2 36 p

a)

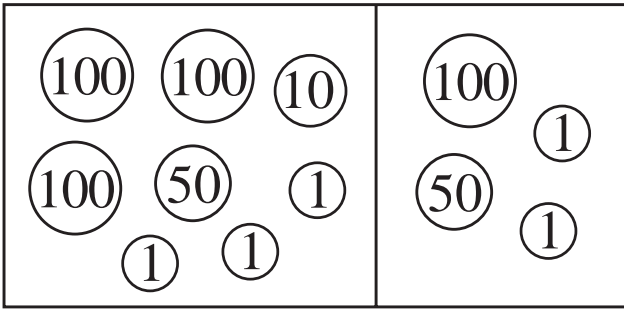

b)

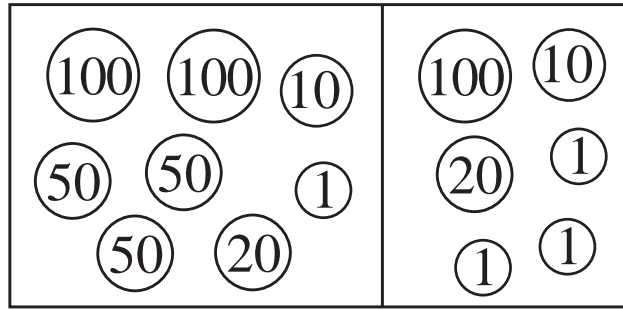

c)

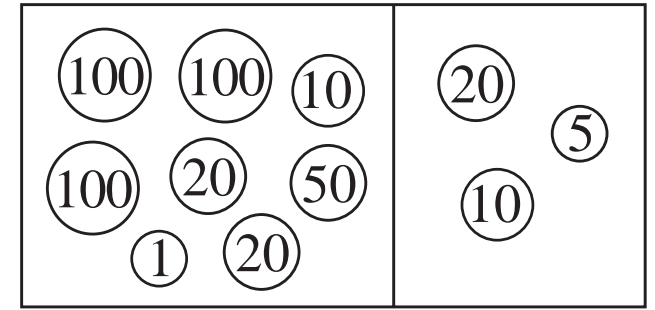

.....

.....

.....

.....

.....

.....

.....

.....

.....

.....

.....

.....

LP 86/7

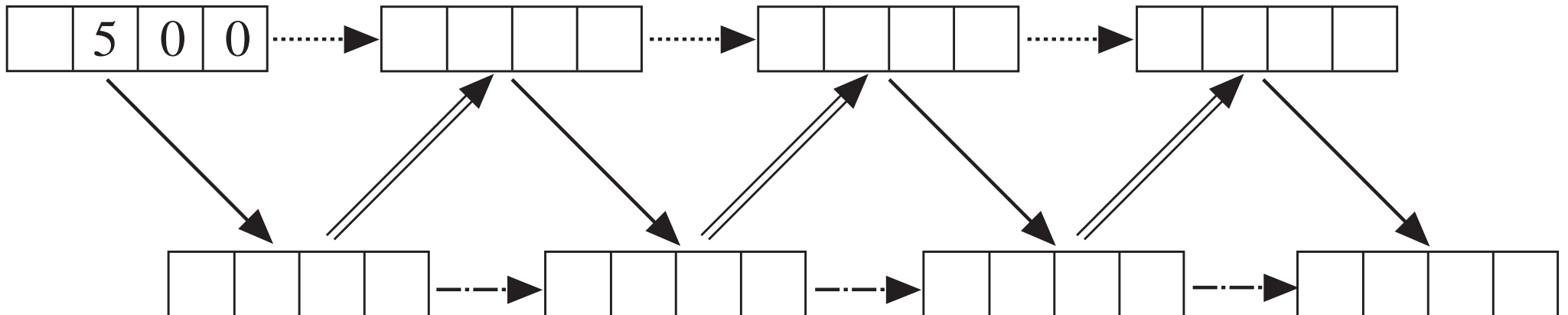



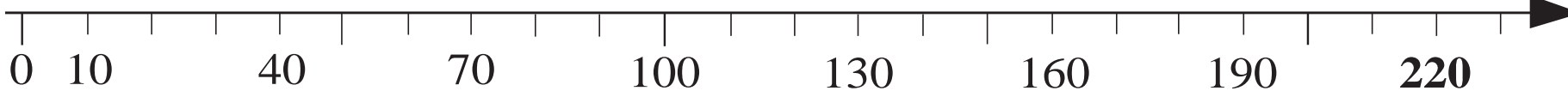
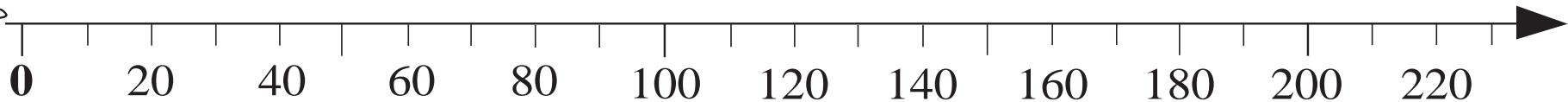

Number of jumps

0

1

2

3

4

5

6

7



8

9

10

11



Number of jumps	0	1	2	3	4	5	6	7	8	9	10	11
												
												

a)

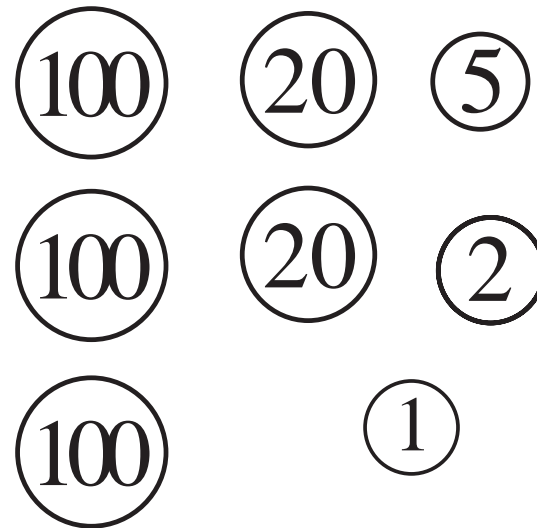
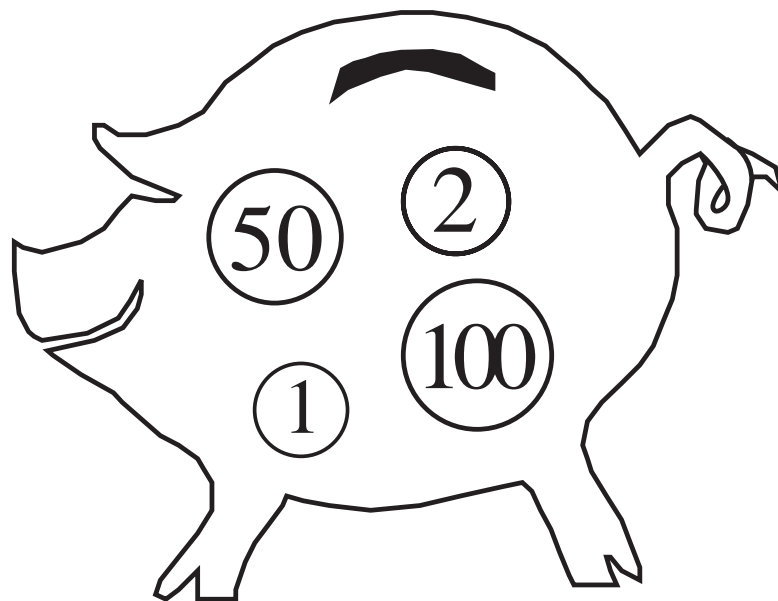
*B**C*

b)

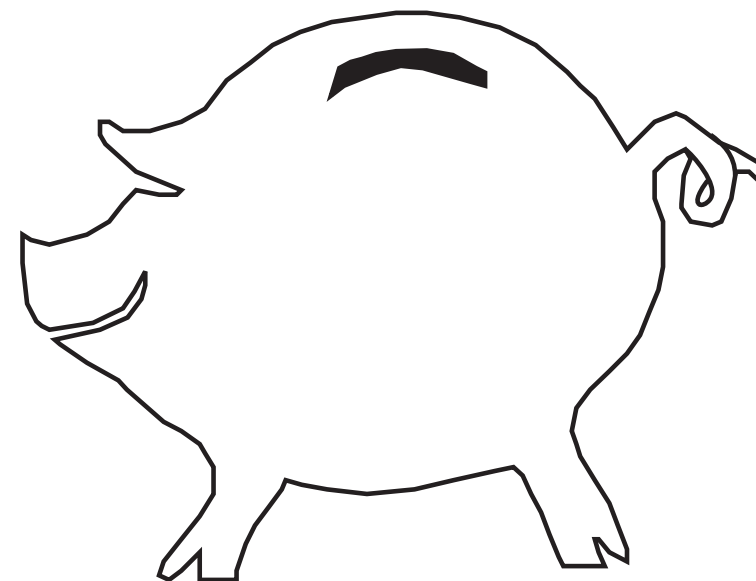
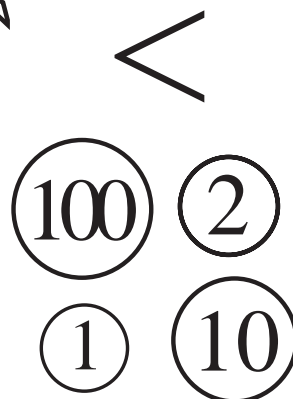
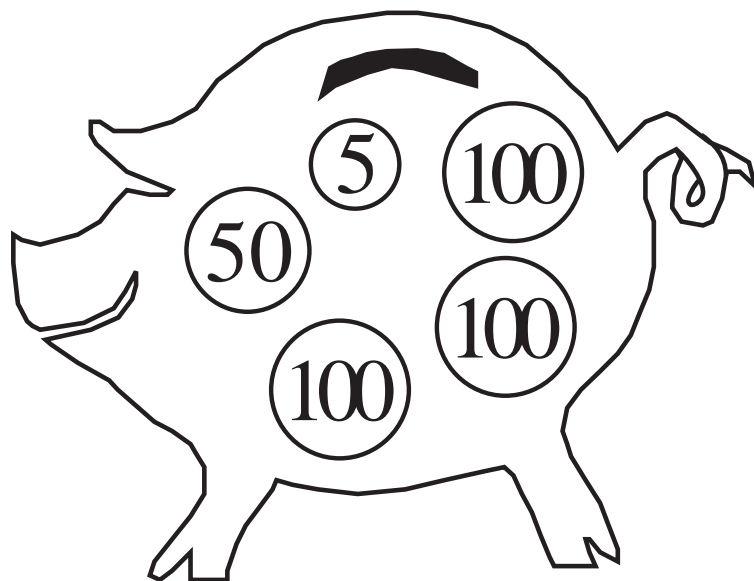

A:

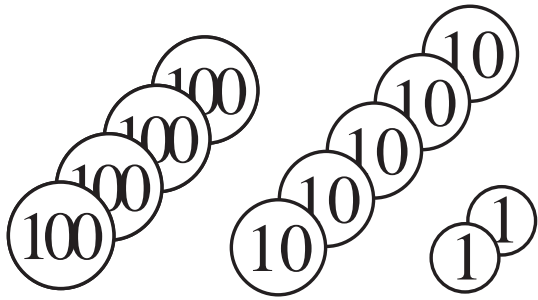
 $\approx$ 

Estimate

--	--	--

Exact amount

--	--	--

B:

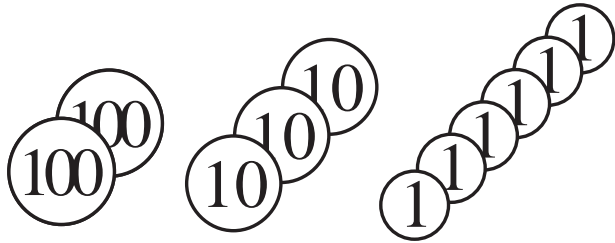
 $\approx$ 

Estimate

--	--	--

Exact amount

--	--	--

A + B:

 $\approx$ 

Estimate

--	--	--

Exact amount

--	--	--

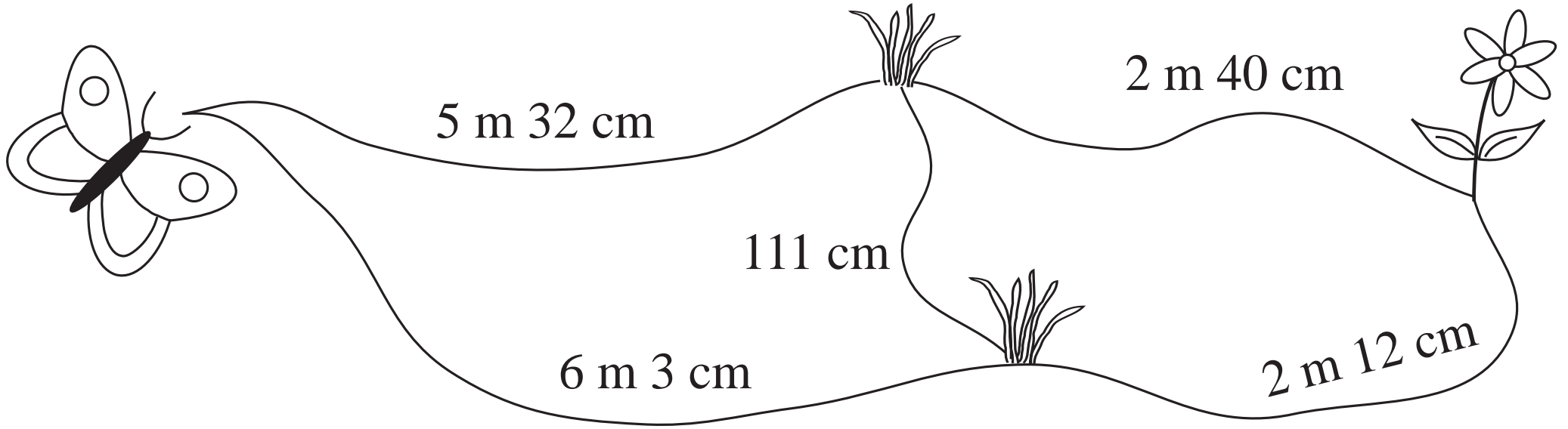

---

---

---

---

---

Hundreds	Tens	Units

H	T	U

Alice:

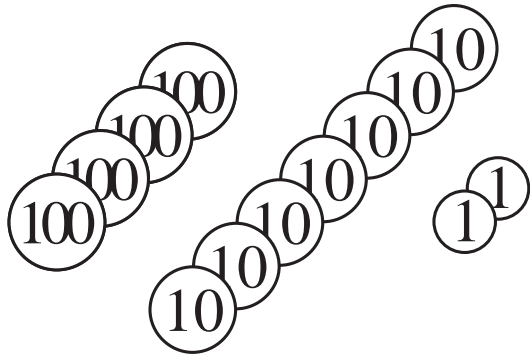

≈

*Estimation*

		0
--	--	---

Sam:

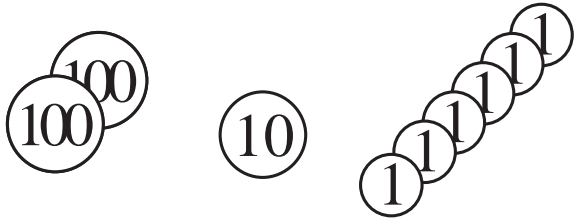

≈

*Estimation*

		0
--	--	---

**Total:**

≈

*Estimation*

		0
--	--	---

A  
S  
T

	H	T	U

Fred:

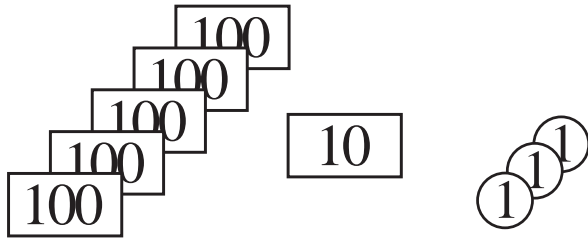

*Estimation*

≈ 

		0
--	--	---

Gordon:

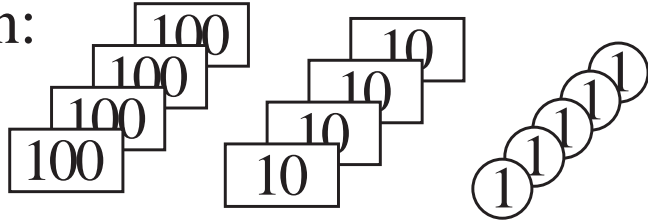

≈ 

		0
--	--	---

**Total:**

≈ 

		0
--	--	---

*Calculation*

	H	T	U
F			
G			
T			

a)  $136 + 312$

 E: 

--	--	--

	H	T	U

b)  $271 + 117$

 E: 

--	--	--

	H	T	U

c)  $632 + 324$

 E: 

--	--	--

	H	T	U

d)  $426 + 32$

 E: 

--	--	--

	H	T	U



Thousands	Hundreds	Tens	Units

Th	H	T	U

a)

	3	4	6
+	2	1	3

b)

	3	4	6
+	3	1	3

c)

	3	4	6
+	1	1	3

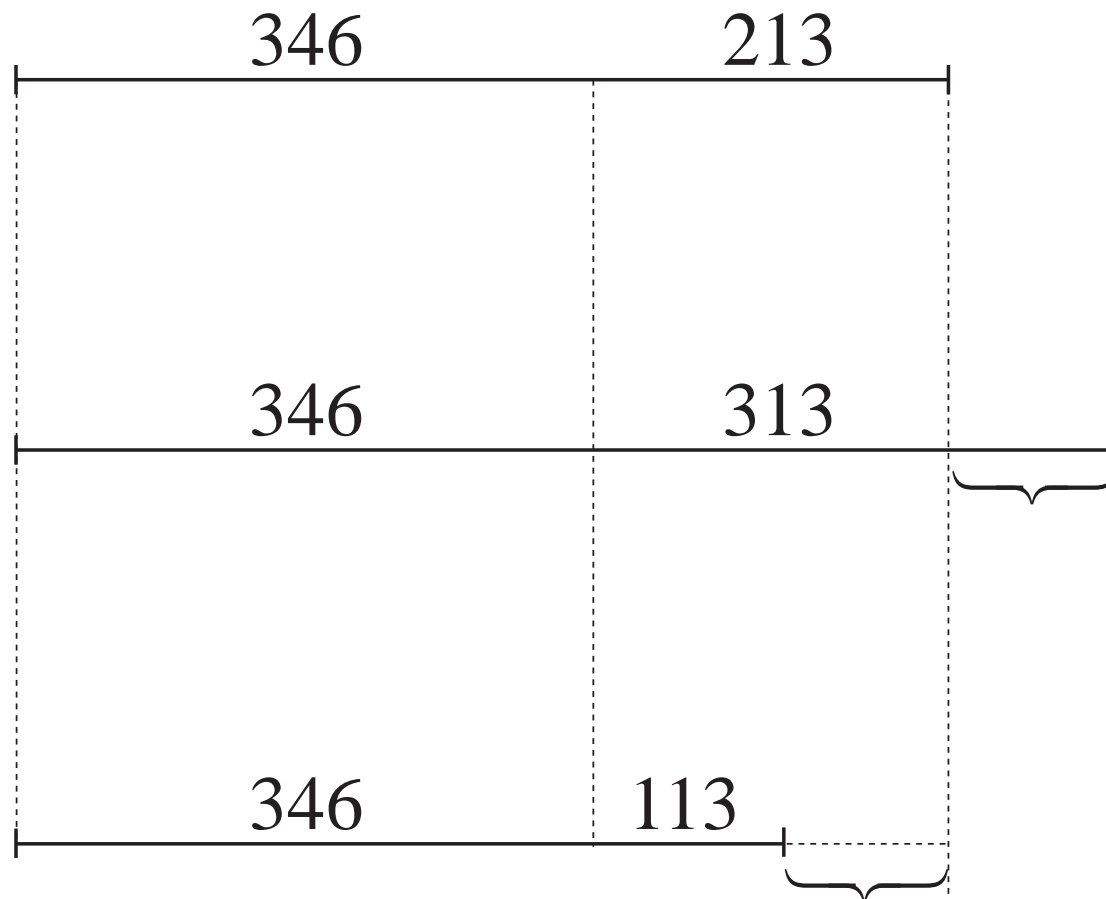

637

650

349

999

461

444

700

1000

600

400

300

500

LP 91/1

A	618	344	192	396	155	743	608	222	555	999	1206
B	600	300									
C	620	340									

LP 93/1

Thousands	Hundreds	Tens	Units

Th	H	T	U

$342 + 753 \quad E: \dots\dots\dots$

Thousands	Hundreds	Tens	Units

Th	H	T	U

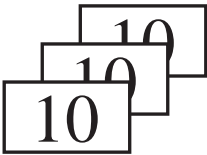
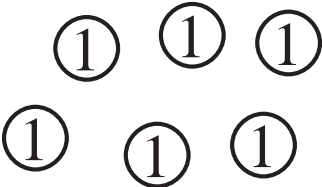
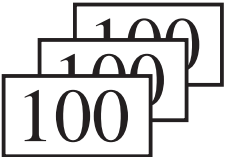
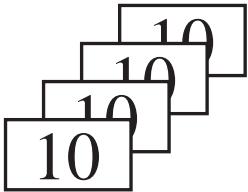
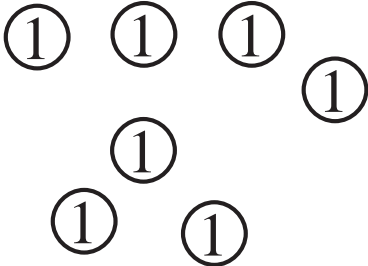
Hundreds	Tens	Units
		
		

H	T	U

$$537 + 259 \approx$$

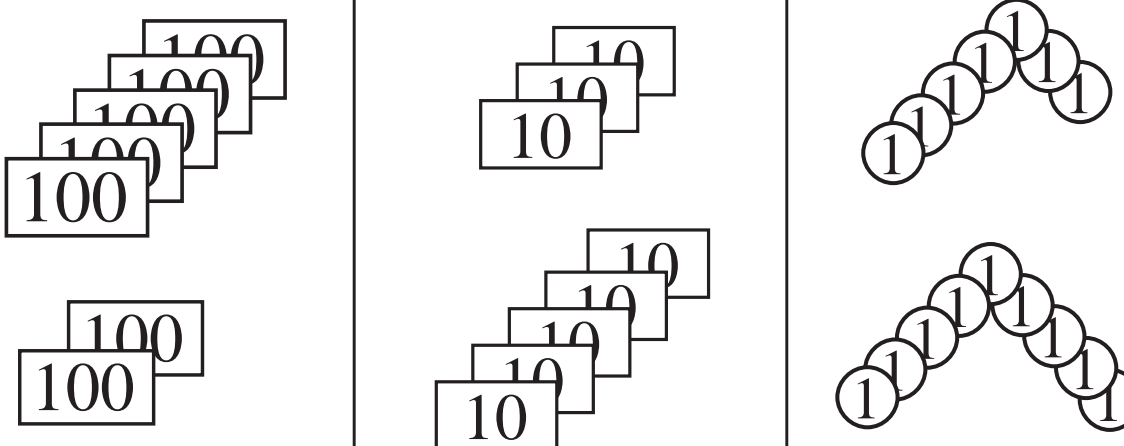
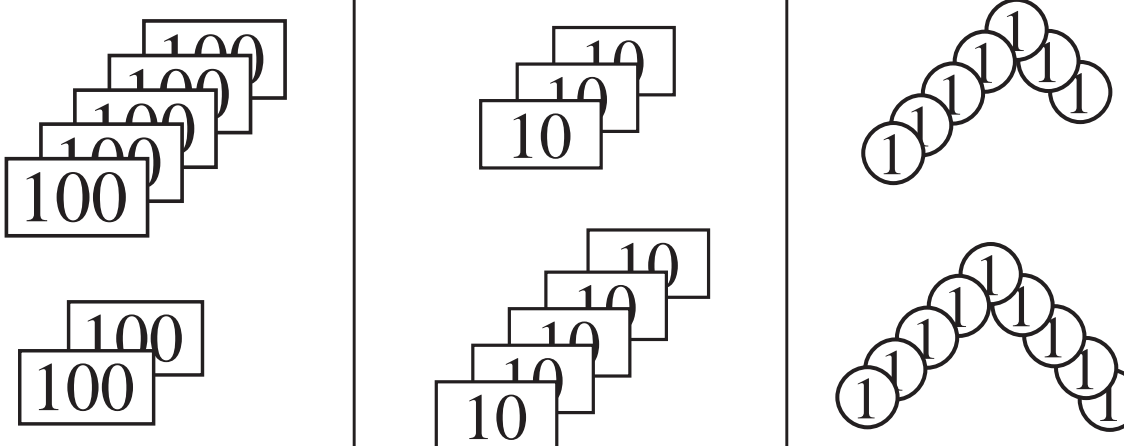
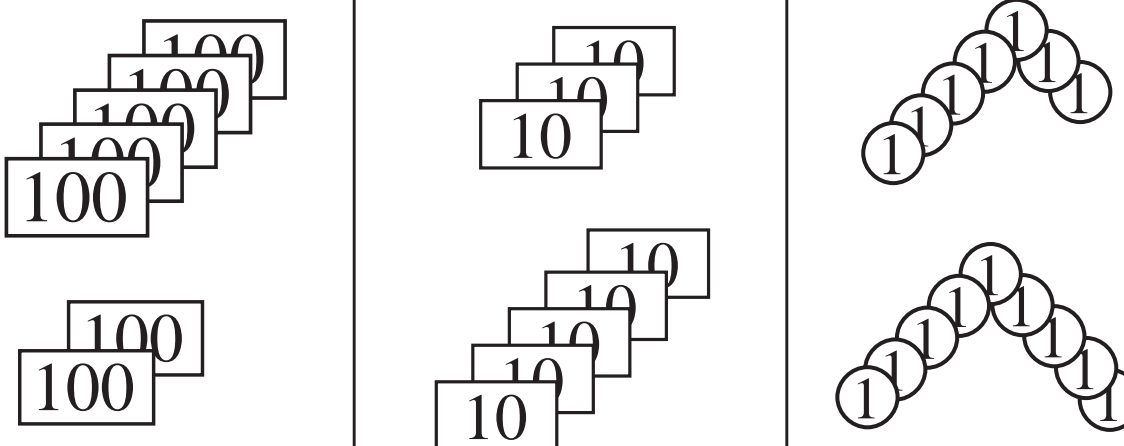
Hundreds	Tens	Units
		

H	T	U

*E:* .....

Hundreds	Tens	Units

H	T	U



a)

	4	5	3
+	2	7	5

b)

	3	5	3
+	3	7	5

c)

	5	5	3
+	1	7	5

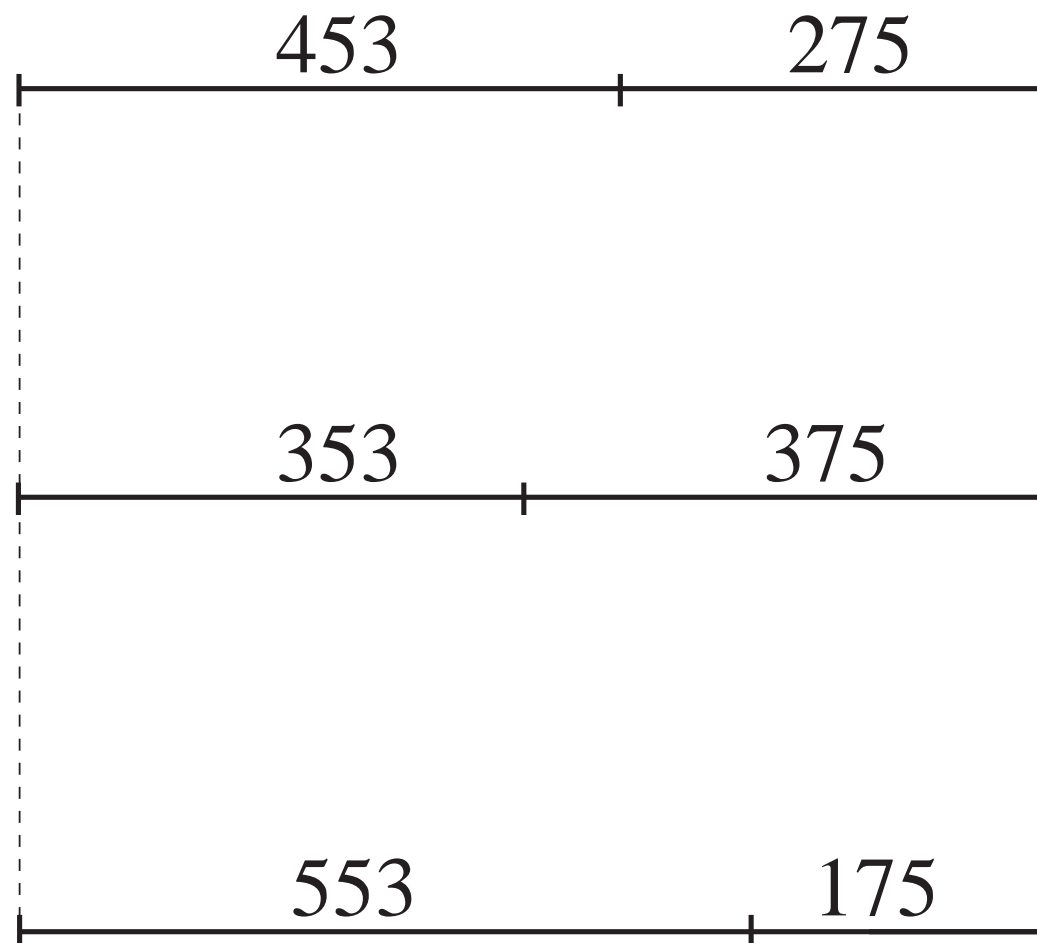

a)  $428 + 541$

 E: 

--	--	--	--

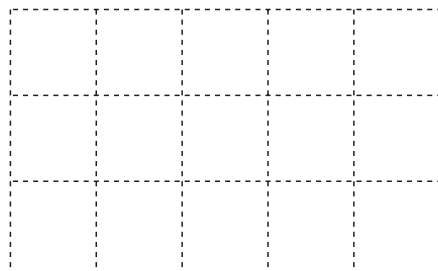

b)  $1328 + 661$

 E: 

--	--	--	--

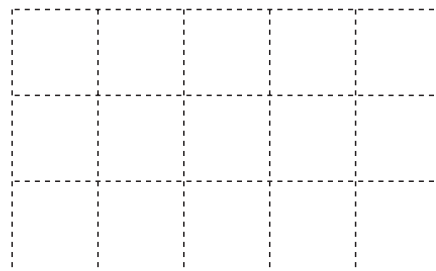

c)  $462 + 1417$

 E: 

--	--	--	--

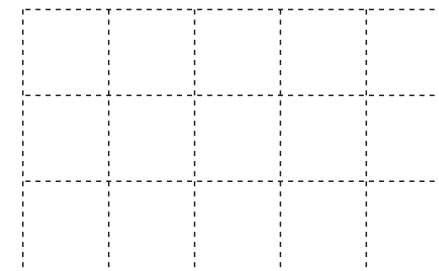

LP 93/6

a) 
$$\begin{array}{r} 221 \\ + 387 \\ \hline 508 \\ \hline \end{array}$$

b) 
$$\begin{array}{r} 532 \\ + 209 \\ \hline 741 \\ \hline \end{array}$$

c) 
$$\begin{array}{r} 459 \\ + 111 \\ \hline 570 \\ \hline \end{array}$$

d) 
$$\begin{array}{r} 833 \\ + 74 \\ \hline 807 \\ \hline \end{array}$$

e) 
$$\begin{array}{r} 567 \\ + 603 \\ \hline 1180 \\ \hline \end{array}$$

LP 93/10

a)

$E:$ 

--	--	--	--

	1	4	3	6
+		3	2	2

 $E:$ 

--	--	--	--

	1	3	6	2
+			9	2

 $E:$ 

--	--	--	--

		5	7	2
+	3	5	6	

 $E:$ 

--	--	--	--

		6	3	8
+	3	2	2	

b)

$E:$ 

--	--	--	--

		8	5	6
+	3	1	2	

 $E:$ 

--	--	--	--

		3	5	8
+	9	1	1	

 $E:$ 

--	--	--	--

		8	6	2
+		9	2	

 $E:$ 

--	--	--	--

		5	0	7
+	4	0	8	

□	□
□	□
□	□
+	

□	□
□	□
□	□
+	

□	□
□	□
□	□
+	

□	□
□	□
□	□
+	

□	□
□	□
□	□
+	

□	□
□	□
□	□
+	

□	□
□	□
□	□
+	

□	□
□	□
□	□
+	

□	□
□	□
□	□
+	

□	□
□	□
□	□
+	

□	□
□	□
□	□
+	

□	□
□	□
□	□
+	

□	□
□	□
□	□
+	

□	□
□	□
□	□
+	

□	□
□	□
□	□
+	

□	□
□	□
□	□
+	

□	□
□	□
□	□
+	

□	□
□	□
□	□
+	

□	□
□	□
□	□
+	

□	□
□	□
□	□
+	

□	□
□	□
□	□
+	

□	□
□	□
□	□
+	

□	□
□	□
□	□
+	

□	□
□	□
□	□
+	

A (£)	134	258	647	376	247	1326		
B (£)	312	427	836				736	542
A + B (£)				898	1062	1810	914	1121

LP 94/2

a)

	3	2	4
+	—	—	—
	5	7	6

b)

	—	—	—
+	4	2	1
	6	7	0

c)

	3	5	—
+	—	2	4
	5	—	6

d)

	3	2	—
+	—	5	7
	1	0	—
			4

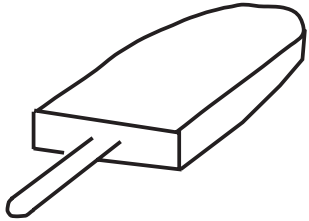

£1 62 p



£1 36 p

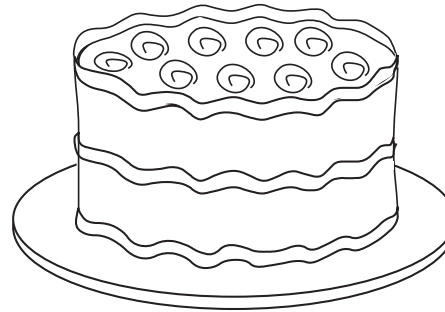

£5 45 p

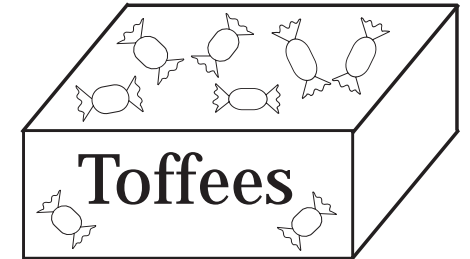

£4 94 p

LP 94/5

a) i)

+	1	2	4	3
	1	5	6	8

ii)

+	9	1	3	
	1	0	4	8

iii)

		5	3	
+				1
		3	4	0

iv)

		5		7	
+	1		8		
		6		5	

v)

		9	7	
+				1
		3	3	

$\begin{array}{r} \square \square \square \\ + \square \square \square \\ \hline \square \square \square \square \\ \hline \end{array}$	$\begin{array}{r} \square \square \square \\ + \square \square \square \\ \hline \square \square \square \square \\ \hline \end{array}$	$\begin{array}{r} \square \square \square \\ + \square \square \square \\ \hline \square \square \square \square \\ \hline \end{array}$	$\begin{array}{r} \square \square \square \\ + \square \square \square \\ \hline \square \square \square \square \\ \hline \end{array}$
---	---	---	---

LP 94/6b

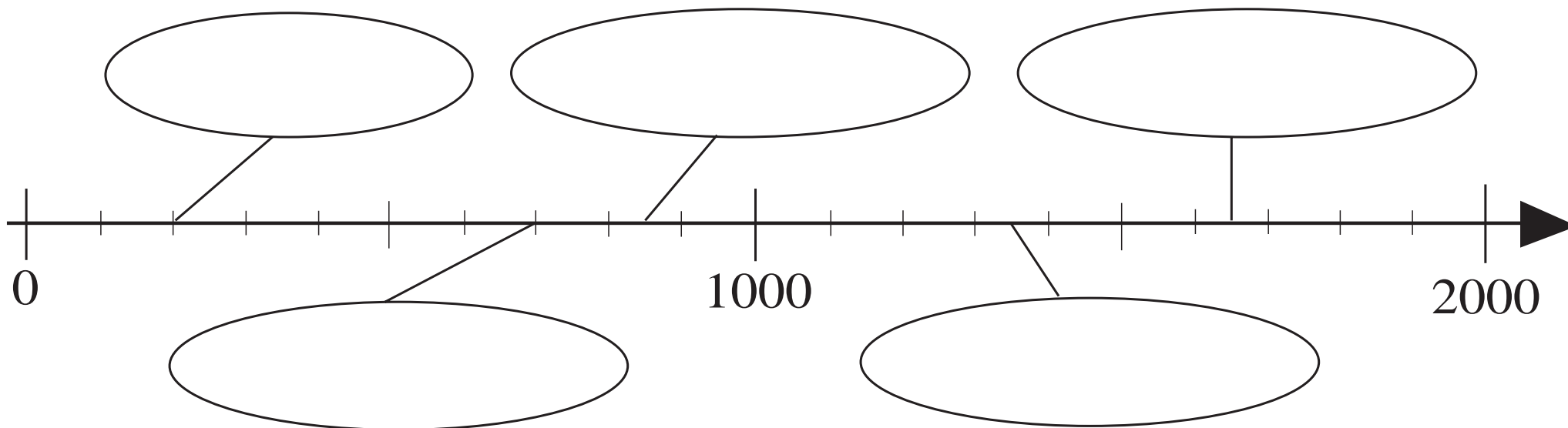

LP 95/4

200

400

700

600

800

679

356

823

175

791

LP 96/1

	340	-----	-----	-----	-----	-----	-----	-----
- 60	↖	680	590	370	960	530	843	999
400	↖							
- 160	↘							
240	↘	-----	-----	-----	-----	-----	-----	-----

LP 97/3



a) Had: 

5
---

 Spent: 

5
---

100	20
-----	----

20	20
----	----

100	20
-----	----

5	5
---	---

Difference

*Estimation:* .....*Exact amount:* .....

b) Had: 

5
---

 Spent:

100	20
-----	----

100	5
-----	---

100	20
-----	----

20	20
----	----

100	10
-----	----

Difference

*Estimation:* .....*Exact amount:* .....

c) Had: 

5
---

 Spent:

100	50
-----	----

100
-----

100
-----

50
----

Difference

*Estimation:* .....*Exact amount:* .....

d) Had: 

5
---

 Spent:

100	100	20
-----	-----	----

100
-----

100	100	20
-----	-----	----

20
----

100
-----

20
----

100	100	②	②
-----	-----	---	---

5
---

Difference

*Estimation:* .....*Exact amount:* .....

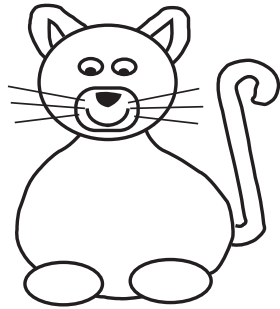

£5.46

 p

£3.56

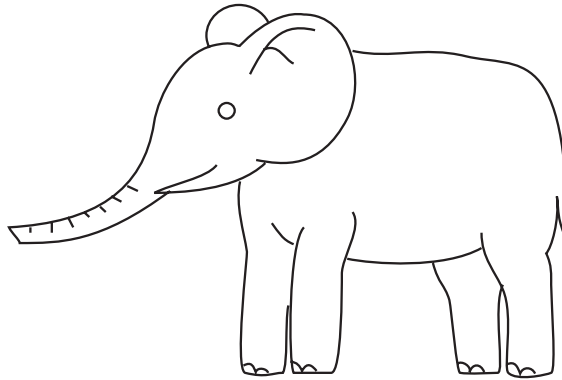
 p

£8.65

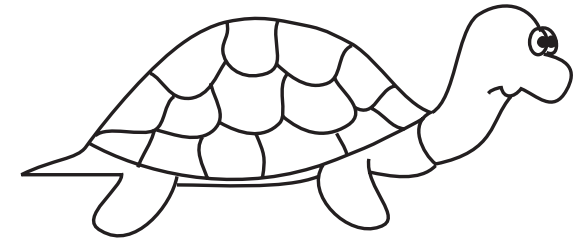
 p

£6.49

 p

a) B – C:  $546 \text{ p} - 356 \text{ p} \approx 550 \text{ p} - 360 \text{ p} = \text{[ ] p}$

b) E – T: ..... = [ ] p

c) E – C: ..... = [ ] p

d) T – B: ..... = [ ] p

$$\text{a) } 674 - 466 \approx \boxed{\phantom{000}} - \boxed{\phantom{000}} = \boxed{\phantom{000}}$$

$$\text{b) } 682 - 444 \approx \boxed{\phantom{000}} - \boxed{\phantom{000}} = \boxed{\phantom{000}}$$

$$\text{c) } 639 - 451 \approx \boxed{\phantom{000}} - \boxed{\phantom{000}} = \boxed{\phantom{000}}$$

$$\text{d) } 926 - 543 \approx \boxed{\phantom{000}} - \boxed{\phantom{000}} = \boxed{\phantom{000}}$$

$$\text{e) } 918 - 550 \approx \boxed{\phantom{000}} - \boxed{\phantom{000}} = \boxed{\phantom{000}}$$

<i>A</i>	832						
<i>B</i>	543						
<i>H</i>	300						
<i>T</i>	290						

a)

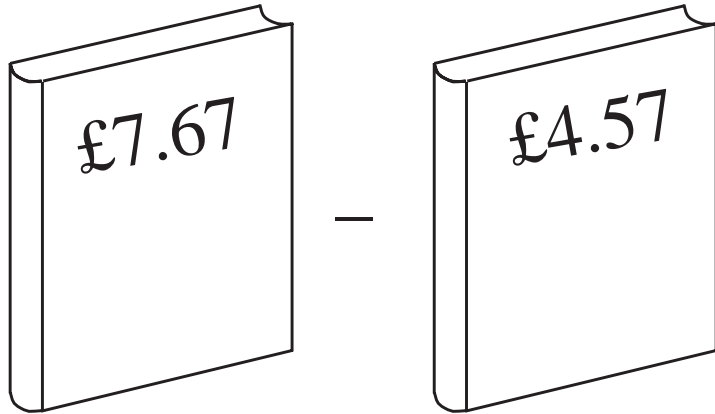

to nearest 100 p:  
.....to nearest 10 p:  
.....

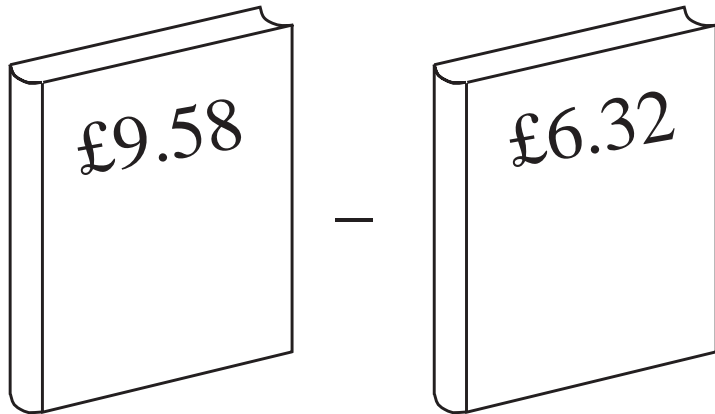
b)

to nearest 100 p:  
.....to nearest 10 p:  
.....

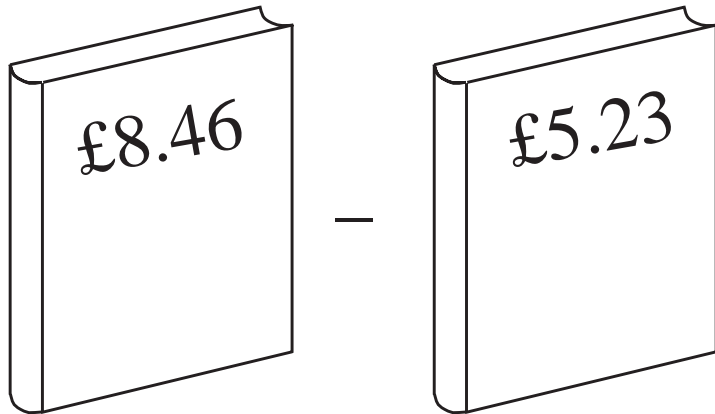
c)

to nearest 100 p:  
.....to nearest 10 p:  
.....

	670	1000	549	394	777		987	* 573	* 464
	420	814	231	384	555	618		348	59
	250	186				275	432		

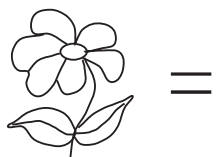



Hundreds	Tens	Units
<div style="text-align: center;"> <div style="border: 1px solid black; padding: 5px; display: inline-block; margin-bottom: 10px;">100</div> <div style="display: flex; justify-content: space-around; width: 100%;"> <div style="border: 1px solid black; padding: 5px; display: inline-block;">100</div> <div style="border: 1px solid black; padding: 5px; display: inline-block;">100</div> </div> </div>	<div style="text-align: center;"> <div style="display: flex; justify-content: space-around; width: 100%;"> <div style="border: 1px solid black; padding: 5px; display: inline-block; margin-bottom: 10px;">10</div> <div style="border: 1px solid black; padding: 5px; display: inline-block; margin-bottom: 10px;">10</div> </div> <div style="text-align: center; margin-bottom: 10px;"> <div style="border: 1px solid black; padding: 5px; display: inline-block;">10</div> </div> <div style="display: flex; justify-content: space-around; width: 100%;"> <div style="border: 1px solid black; padding: 5px; display: inline-block;">10</div> <div style="border: 1px solid black; padding: 5px; display: inline-block;">10</div> </div> </div>	<div style="text-align: center;"> <div style="display: flex; justify-content: space-around; width: 100%;"> <div style="border: 1px solid black; border-radius: 50%; padding: 5px; display: inline-block; margin-bottom: 10px;">1</div> <div style="border: 1px solid black; border-radius: 50%; padding: 5px; display: inline-block; margin-bottom: 10px;">1</div> </div> <div style="display: flex; justify-content: space-around; width: 100%;"> <div style="border: 1px solid black; border-radius: 50%; padding: 5px; display: inline-block;">1</div> <div style="border: 1px solid black; border-radius: 50%; padding: 5px; display: inline-block;">1</div> </div> </div>
+		
<div style="text-align: center;"> <div style="display: flex; justify-content: space-around; width: 100%;"> <div style="border: 1px solid black; padding: 5px; display: inline-block; margin-bottom: 10px;">100</div> <div style="border: 1px solid black; padding: 5px; display: inline-block; margin-bottom: 10px;">100</div> </div> <div style="text-align: center; margin-bottom: 10px;"> <div style="border: 1px solid black; padding: 5px; display: inline-block;">100</div> </div> <div style="display: flex; justify-content: space-around; width: 100%;"> <div style="border: 1px solid black; padding: 5px; display: inline-block;">100</div> <div style="border: 1px solid black; padding: 5px; display: inline-block;">100</div> </div> </div>	<div style="text-align: center;"> <div style="display: flex; justify-content: space-around; width: 100%;"> <div style="border: 1px solid black; padding: 5px; display: inline-block; margin-bottom: 10px;">10</div> <div style="border: 1px solid black; padding: 5px; display: inline-block; margin-bottom: 10px;">10</div> </div> <div style="display: flex; justify-content: space-around; width: 100%;"> <div style="border: 1px solid black; padding: 5px; display: inline-block; margin-bottom: 10px;">10</div> <div style="border: 1px solid black; padding: 5px; display: inline-block; margin-bottom: 10px;">10</div> </div> <div style="display: flex; justify-content: space-around; width: 100%;"> <div style="border: 1px solid black; padding: 5px; display: inline-block;">10</div> <div style="border: 1px solid black; padding: 5px; display: inline-block;">10</div> </div> </div>	<div style="text-align: center;"> <div style="display: flex; justify-content: space-around; width: 100%;"> <div style="border: 1px solid black; border-radius: 50%; padding: 5px; display: inline-block; margin-bottom: 10px;">1</div> <div style="border: 1px solid black; border-radius: 50%; padding: 5px; display: inline-block; margin-bottom: 10px;">1</div> <div style="border: 1px solid black; border-radius: 50%; padding: 5px; display: inline-block; margin-bottom: 10px;">1</div> <div style="border: 1px solid black; border-radius: 50%; padding: 5px; display: inline-block; margin-bottom: 10px;">1</div> </div> <div style="text-align: center; margin-bottom: 10px;"> <div style="border: 1px solid black; border-radius: 50%; padding: 5px; display: inline-block;">1</div> </div> <div style="display: flex; justify-content: space-around; width: 100%;"> <div style="border: 1px solid black; border-radius: 50%; padding: 5px; display: inline-block;">1</div> <div style="border: 1px solid black; border-radius: 50%; padding: 5px; display: inline-block;">1</div> </div> </div>

H	T	U

Hundreds	Tens	Units
<div style="display: flex; justify-content: space-around;"> <div style="border: 1px solid black; padding: 5px;">100</div> <div style="border: 1px solid black; padding: 5px;">100</div> </div> <div style="text-align: center; margin: 10px 0;"> <div style="border: 1px solid black; padding: 5px;">100</div> </div> <div style="display: flex; justify-content: space-around;"> <div style="border: 1px solid black; padding: 5px;">100</div> <div style="border: 1px solid black; padding: 5px;">100</div> </div>	<div style="display: flex; justify-content: space-around;"> <div style="border: 1px solid black; padding: 5px;">10</div> <div style="border: 1px solid black; padding: 5px;">10</div> </div> <div style="display: flex; justify-content: space-around; margin: 10px 0;"> <div style="border: 1px solid black; padding: 5px;">10</div> <div style="border: 1px solid black; padding: 5px;">10</div> </div> <div style="display: flex; justify-content: space-around;"> <div style="border: 1px solid black; padding: 5px;">10</div> <div style="border: 1px solid black; padding: 5px;">10</div> </div>	<div style="display: flex; justify-content: space-around;"> <div style="border: 1px solid black; border-radius: 50%; padding: 5px;">1</div> <div style="border: 1px solid black; border-radius: 50%; padding: 5px;">1</div> <div style="border: 1px solid black; border-radius: 50%; padding: 5px;">1</div> </div> <div style="text-align: right; margin: 10px 0;"> <div style="border: 1px solid black; border-radius: 50%; padding: 5px;">1</div> </div> <div style="display: flex; justify-content: space-around; margin: 10px 0;"> <div style="border: 1px solid black; border-radius: 50%; padding: 5px;">1</div> <div style="border: 1px solid black; border-radius: 50%; padding: 5px;">1</div> </div>
<div style="text-align: center; margin: 10px 0;"> <div style="border: 1px solid black; padding: 5px;">100</div> </div> <div style="display: flex; justify-content: space-around;"> <div style="border: 1px solid black; padding: 5px;">100</div> <div style="border: 1px solid black; padding: 5px;">100</div> </div>	<div style="display: flex; justify-content: space-around;"> <div style="border: 1px solid black; padding: 5px;">10</div> <div style="border: 1px solid black; padding: 5px;">10</div> </div> <div style="text-align: center; margin: 10px 0;"> <div style="border: 1px solid black; padding: 5px;">10</div> </div> <div style="display: flex; justify-content: space-around;"> <div style="border: 1px solid black; padding: 5px;">10</div> <div style="border: 1px solid black; padding: 5px;">10</div> </div>	<div style="display: flex; justify-content: space-around;"> <div style="border: 1px solid black; border-radius: 50%; padding: 5px;">1</div> <div style="border: 1px solid black; border-radius: 50%; padding: 5px;">1</div> </div> <div style="display: flex; justify-content: space-around; margin: 10px 0;"> <div style="border: 1px solid black; border-radius: 50%; padding: 5px;">1</div> <div style="border: 1px solid black; border-radius: 50%; padding: 5px;">1</div> </div>

H	T	U



a)

$$\begin{array}{r}
 543 \\
 + \quad \quad \quad \\
 \hline
 875
 \end{array}$$

$$\begin{array}{r}
 875 \\
 - 543 \\
 \hline
 \quad \quad \quad
 \end{array}$$

b)

$$\begin{array}{r}
 156 \\
 + \quad \quad \quad \\
 \hline
 989
 \end{array}$$

$$\begin{array}{r}
 \quad \quad \quad \\
 \quad \quad \quad \\
 \quad \quad \quad \\
 \hline
 \quad \quad \quad
 \end{array}$$

c)

$$\begin{array}{r}
 217 \\
 + \quad \quad \quad \\
 \hline
 659
 \end{array}$$

$$\begin{array}{r}
 \quad \quad \quad \\
 \quad \quad \quad \\
 \quad \quad \quad \\
 \hline
 \quad \quad \quad
 \end{array}$$

d)

$$\begin{array}{r}
 632 \\
 + \quad \quad \quad \\
 \hline
 867
 \end{array}$$

$$\begin{array}{r}
 \quad \quad \quad \\
 \quad \quad \quad \\
 \quad \quad \quad \\
 \hline
 \quad \quad \quad
 \end{array}$$



e)

$$\begin{array}{r}
 1254 \\
 + \quad \quad \quad \\
 \hline
 1896
 \end{array}$$

$$\begin{array}{r}
 \quad \quad \quad \\
 \quad \quad \quad \\
 \quad \quad \quad \\
 \hline
 \quad \quad \quad
 \end{array}$$

LP 98/2

$$\text{mushroom} - 80 = \text{flower}$$

	790	830		950	440			710	620	519
			320			520	670			777

LP 99/1

a) i)

3	8	6
2	1	5

ii)

3	8	6
2	1	6

iii)

3	8	6
2	1	7

iv)

3	8	6
2	1	8

b) i)

7	6	8
2	4	5

ii)

7	6	8
2	6	5

iii)

7	6	8
2	8	5

iv)

7	6	8
3	0	5

c) i)

5	0	4
3	0	1

ii)

5	0	4
3	1	1

iii)

5	0	4
3	2	1

iv)

5	0	4
3	3	1

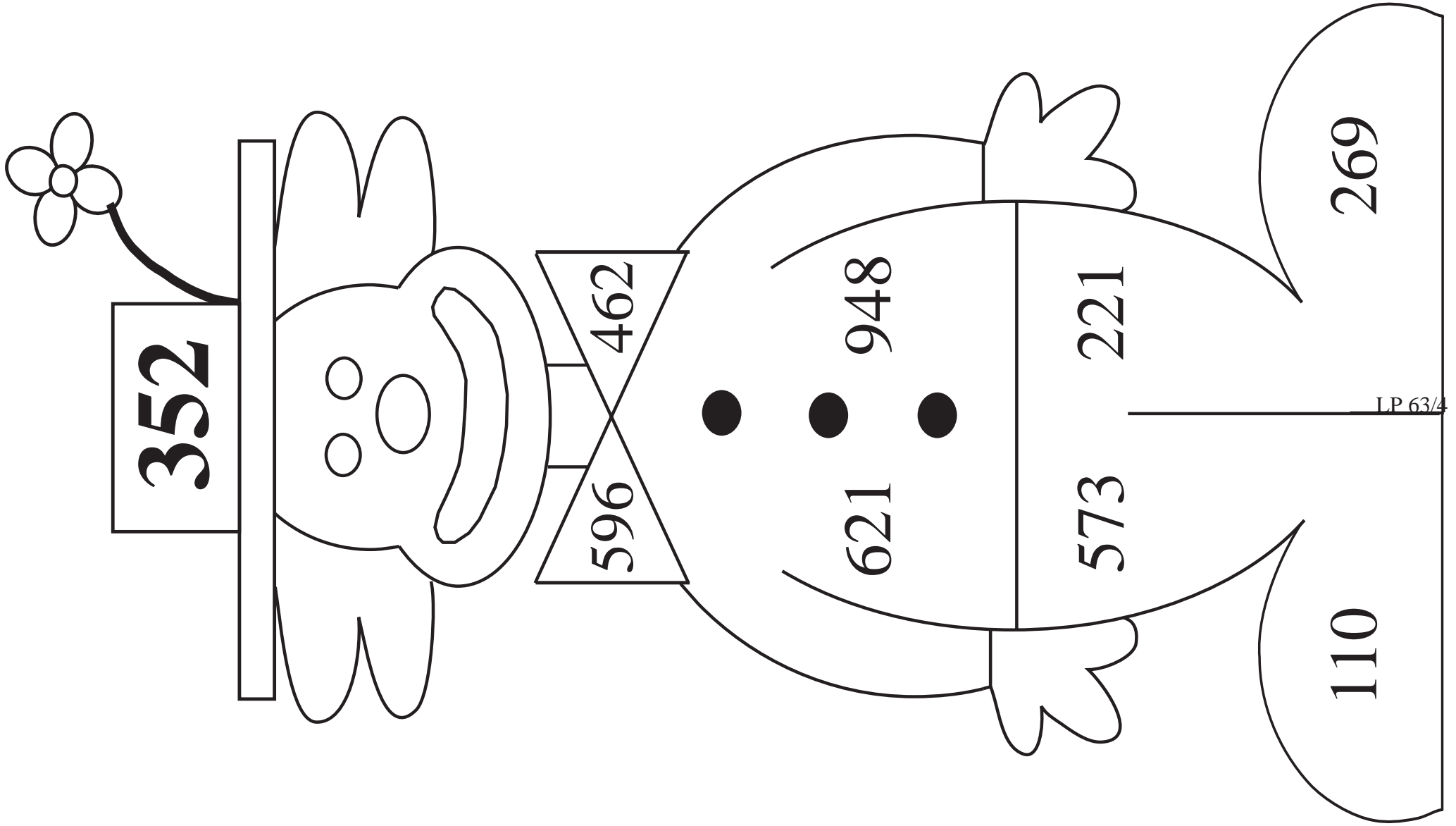

LP 63/4

a)  $440 =$  100 100 100 50  20 20

b)  $540 =$  100 100 100 50 50  20

20 20 20 20 20

c)  $400 =$  100 50 50 50 50 20 20

20 20 10

d)  $580 =$  100 50  50 50 50 100

20 20 20 20

a)

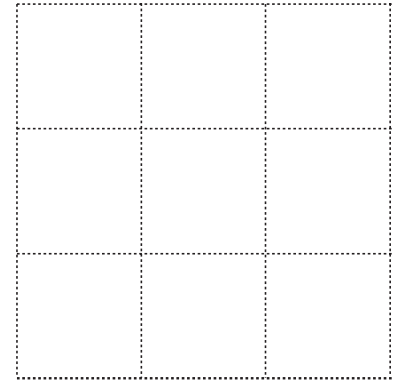

b)

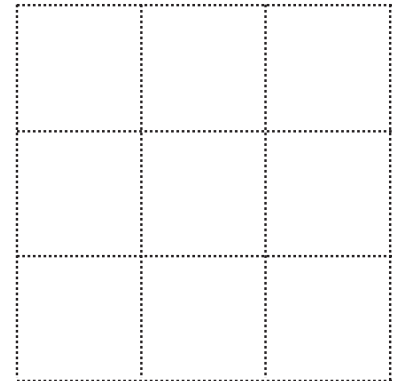

c)

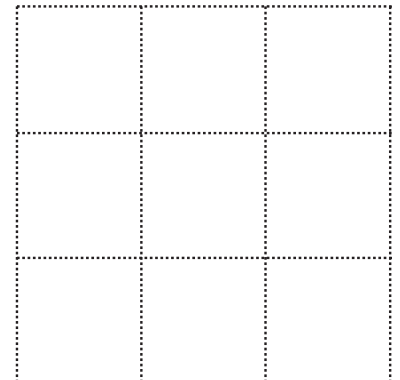



$$\begin{array}{r} 628 \\ - 214 \\ \hline \end{array}$$

$$\begin{array}{r} 574 \\ - 341 \\ \hline \end{array}$$

$$\begin{array}{r} 845 \\ - 573 \\ \hline \end{array}$$

$$\begin{array}{r} 837 \\ - 299 \\ \hline \end{array}$$

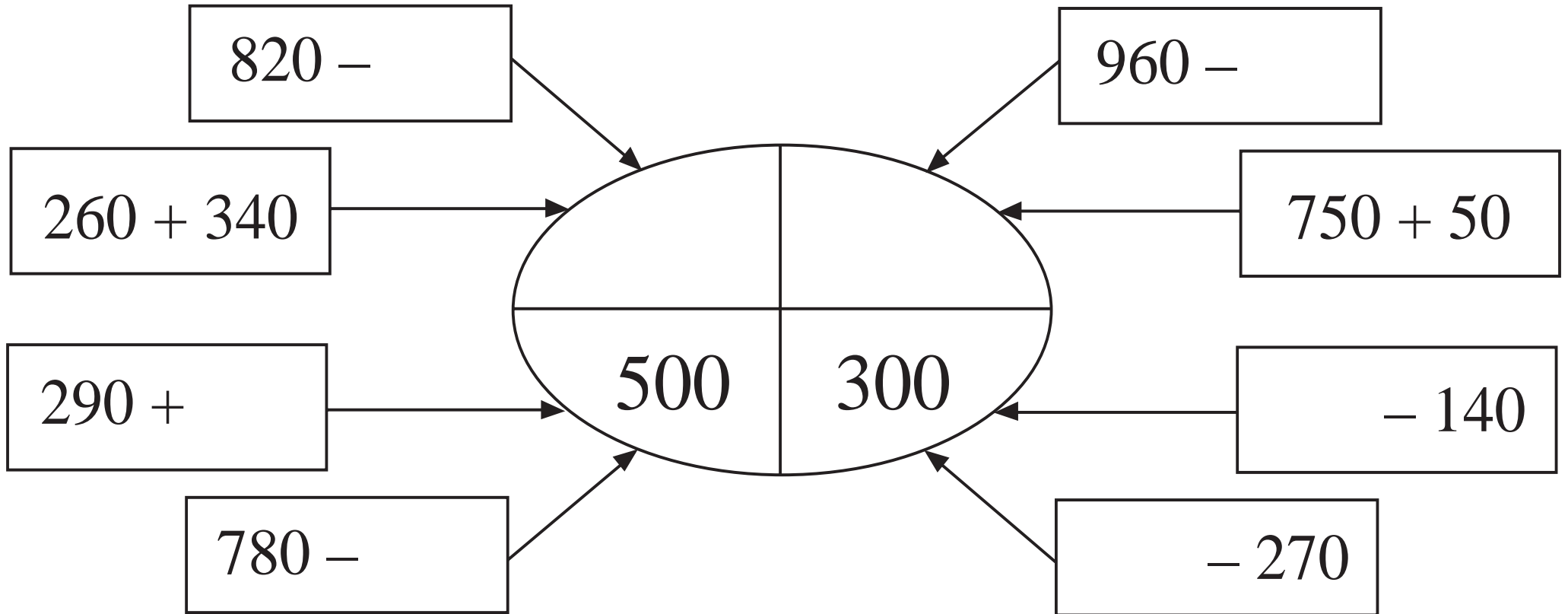

a)

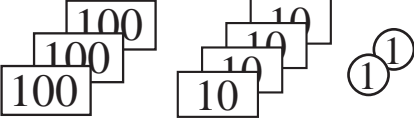
 Had:   $\approx$ 

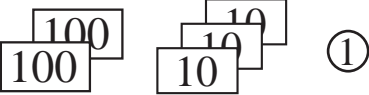
 Spent:   $\approx$ 

 Had left:  $\approx$ 
*Estimation*

--	--	--

*Calculation*

	Th	H	T	U

*Check*

	Th	H	T	U

b)

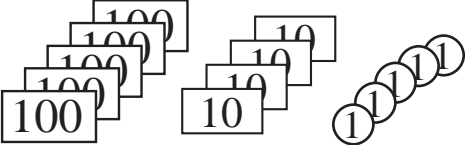
 Had:   $\approx$ 

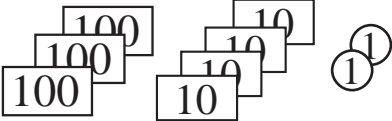
 Spent:   $\approx$ 

 Had left:  $\approx$ 
*Estimation*

--	--	--

*Calculation*

*Check*



a) i)

$$\begin{array}{r}
 943 \\
 - 612 \\
 \hline
 \end{array}$$

$$E: \begin{array}{|c|c|c|} \hline & & \\ \hline \end{array}$$

ii)

$$\begin{array}{r}
 785 \\
 - 245 \\
 \hline
 \end{array}$$

$$E: \begin{array}{|c|c|c|} \hline & & \\ \hline \end{array}$$

iii)

$$\begin{array}{r}
 847 \\
 - 346 \\
 \hline
 \end{array}$$

$$E: \begin{array}{|c|c|c|} \hline & & \\ \hline \end{array}$$

iv)

$$\begin{array}{r}
 1864 \\
 - 1352 \\
 \hline
 \end{array}$$

$$E: \begin{array}{|c|c|c|} \hline & & \\ \hline \end{array}$$

v)

$$\begin{array}{r}
 1756 \\
 - \quad 652 \\
 \hline
 \end{array}$$

$$E: \begin{array}{|c|c|c|c|} \hline & & & \\ \hline \end{array}$$

b) i)

$$\begin{array}{r}
 872 \\
 - 356 \\
 \hline
 \end{array}$$

$$E: \begin{array}{|c|c|c|} \hline & & \\ \hline \end{array}$$

ii)

$$\begin{array}{r}
 780 \\
 - 357 \\
 \hline
 \end{array}$$

$$E: \begin{array}{|c|c|c|} \hline & & \\ \hline \end{array}$$

iii)

$$\begin{array}{r}
 825 \\
 - 609 \\
 \hline
 \end{array}$$

$$E: \begin{array}{|c|c|c|} \hline & & \\ \hline \end{array}$$

iv)

$$\begin{array}{r}
 735 \\
 - 482 \\
 \hline
 \end{array}$$

$$E: \begin{array}{|c|c|c|} \hline & & \\ \hline \end{array}$$

v)

$$\begin{array}{r}
 903 \\
 - 571 \\
 \hline
 \end{array}$$

$$E: \begin{array}{|c|c|c|} \hline & & \\ \hline \end{array}$$

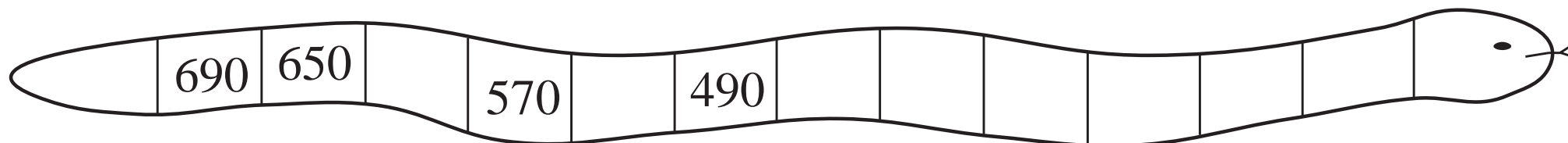

LP 101/1

$$\begin{array}{r} \text{a)} \quad 476 \\ - 345 \\ \hline 131 \\ \hline \end{array}$$

$$\begin{array}{r} \text{b)} \quad 345 \\ - 138 \\ \hline 21\textcircled{3} \rightarrow 210 - 3 = \underline{207} \end{array}$$

$$\begin{array}{r} \text{c)} \quad 539 \\ - 294 \\ \hline 3\textcircled{6}5 \rightarrow 305 - 60 = \underline{245} \end{array}$$

$$\begin{array}{r} \text{d)} \quad 643 \\ - 389 \\ \hline 3\textcircled{4}\textcircled{6} \rightarrow 300 - 46 = \underline{254} \end{array}$$

LP 101/4

$$\begin{array}{r} \text{a)} \quad 1648 \\ - 132 \\ \hline 328 \\ \hline \end{array}$$

---

$$\begin{array}{r} \text{b)} \quad 1679 \\ - 56 \\ \hline 1119 \\ \hline \end{array}$$

---

$$\begin{array}{r} \text{c)} \quad 725 \\ - 467 \\ \hline 342 \\ \hline \end{array}$$

---

$$\begin{array}{r} \text{d)} \quad 845 \\ - 325 \\ \hline 52 \\ \hline \end{array}$$

a)

$$\begin{array}{r} 845 \\ - 672 \\ \hline \end{array}$$

$<$

100

$$\begin{array}{r} \boxed{\phantom{000}} \\ - 672 \\ \hline \end{array}$$

b)

$$\begin{array}{r} 1076 \\ - 491 \\ \hline \end{array}$$

$>$

200

$$\begin{array}{r} 976 \\ - \boxed{\phantom{000}} \\ \hline \end{array}$$

c)

$$\begin{array}{r} 856 \\ - 245 \\ \hline \end{array}$$

$=$

$$\begin{array}{r} 756 \\ - \boxed{\phantom{000}} \\ \hline \end{array}$$

d)

$$\begin{array}{r} 917 \\ - 583 \\ \hline \end{array}$$

$=$

$$\begin{array}{r} \boxed{\phantom{000}} \\ - 383 \\ \hline \end{array}$$

$\begin{array}{r} 868 \\ - 213 \\ \hline \square \end{array}$	$\begin{array}{r} \square \\ - 132 \\ \hline \square \end{array}$	$\begin{array}{r} \square \\ - 221 \\ \hline \square \end{array}$	$\begin{array}{r} \square \\ - 149 \\ \hline \square \end{array}$	$\begin{array}{r} \square \\ - 33 \\ \hline \square \end{array}$
---	---	---	---	--

LP 101/5

a)

<i>A</i>	321		238		372		537		73	
<i>B</i>		515		409		681		723		918

b)

<i>C</i>	756		876		909		1058		1567	
<i>D</i>		123		409		317		723		1283

LP 101/8

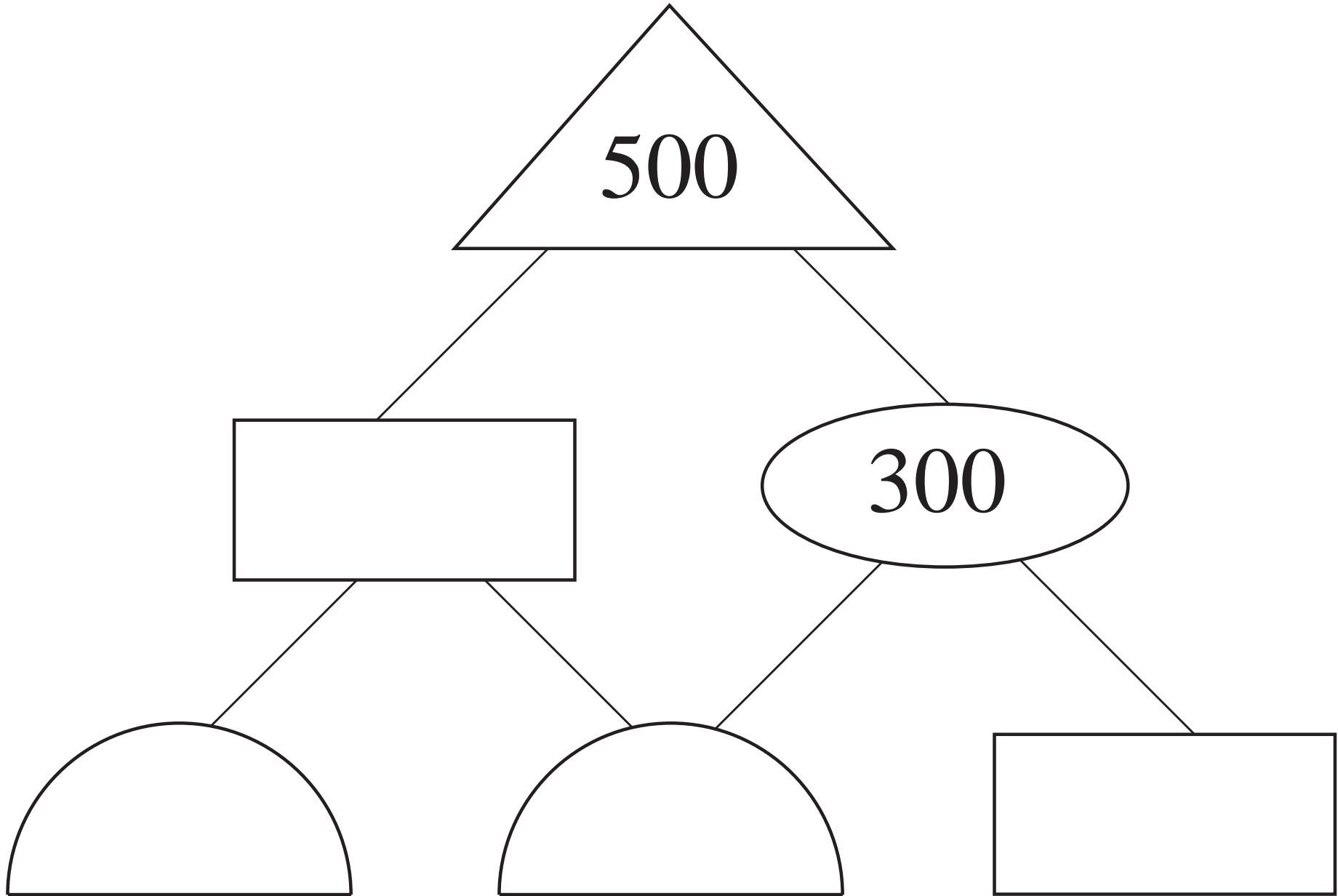

<b>555</b>		<b>444</b>	<b>=</b>	<b>999</b>
		<b>111</b>	<b>=</b>	
<b>=</b>		<b>=</b>		<b>=</b>
<b>222</b>			<b>=</b>	<b>555</b>

a) 
$$\begin{array}{r} 876 \\ - 154 \\ \hline \end{array}$$

b) 
$$\begin{array}{r} 952 \\ - \phantom{000} \\ \hline 248 \end{array}$$

c) 
$$\begin{array}{r} \phantom{000} \\ - 456 \\ \hline 513 \end{array}$$

d) 
$$\begin{array}{r} 859 \\ - 327 \\ \hline \end{array}$$

e) 
$$\begin{array}{r} 1764 \\ - \phantom{0000} \\ \hline \phantom{00}246 \end{array}$$

LP 102/9

a) 
$$\begin{array}{r} \phantom{000} \\ + 142 \\ \hline 597 \end{array}$$

b) 
$$\begin{array}{r} \phantom{000} \\ + 305 \\ \hline 678 \end{array}$$

c) 
$$\begin{array}{r} \phantom{0000} \\ + 1325 \\ \hline 1879 \end{array}$$

d) 
$$\begin{array}{r} 1356 \\ + \phantom{0000} \\ \hline 1606 \end{array}$$

e) 
$$\begin{array}{r} \phantom{0000} \\ + \phantom{00}53 \\ \hline \phantom{00}46 \phantom{00} \\ \hline \phantom{00}0 \phantom{00}3 \end{array}$$

$$\begin{array}{r} 597 \\ - \phantom{000} \\ \hline \end{array}$$

$$\begin{array}{r} \phantom{000} \\ - \phantom{000} \\ \hline \end{array}$$

$$\begin{array}{r} \phantom{0000} \\ - \phantom{0000} \\ \hline \end{array}$$

$$\begin{array}{r} \phantom{0000} \\ - \phantom{0000} \\ \hline \end{array}$$

$$\begin{array}{r} \phantom{0000} \\ - \phantom{0000} \\ \hline \end{array}$$

LP 103/6



a)

-	6	7	3
	3	2	1

b)

-	4	9	6
	2	7	2

c)

-	8	9	3
	6	2	8

d)

-	5	4	1
	3	5	2

LP 103/7

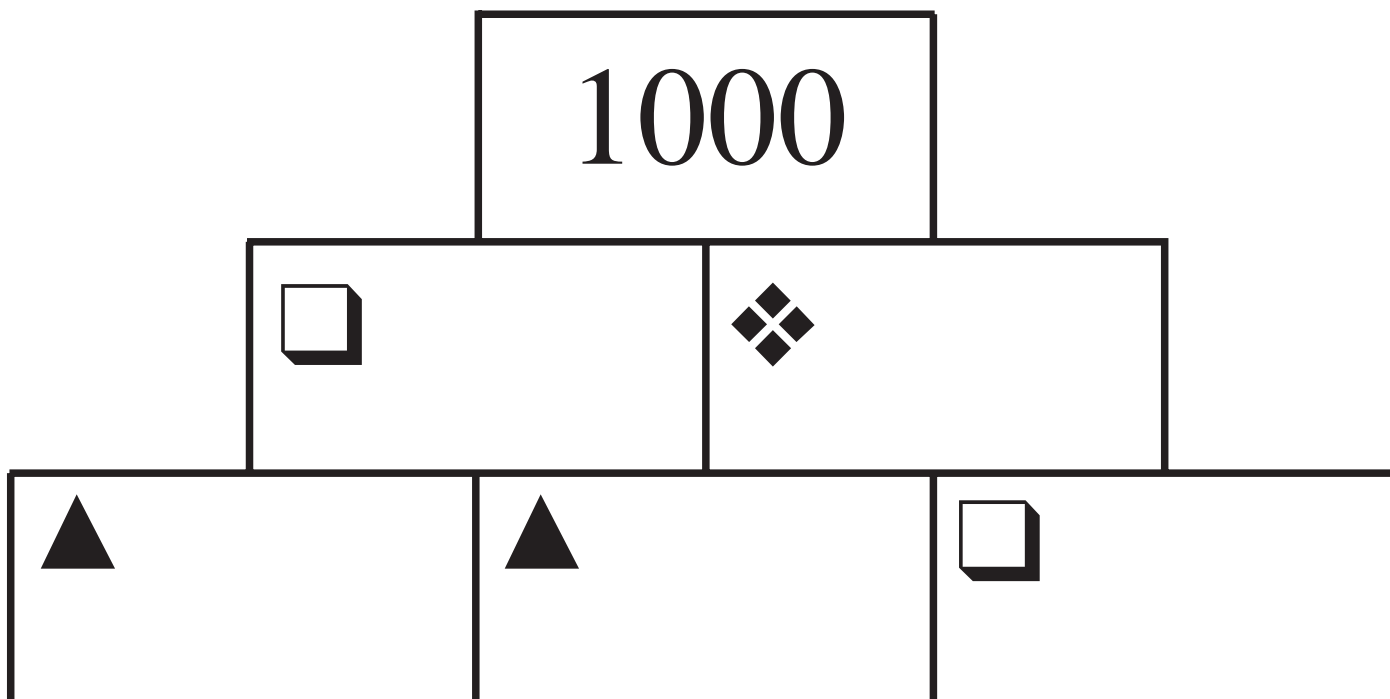

a) at least 300

-			

b) the smallest possible

-			

c) between 200 and 300

-			

d) even

-			

e) the greatest possible

-			

f) divisible by 10

-			

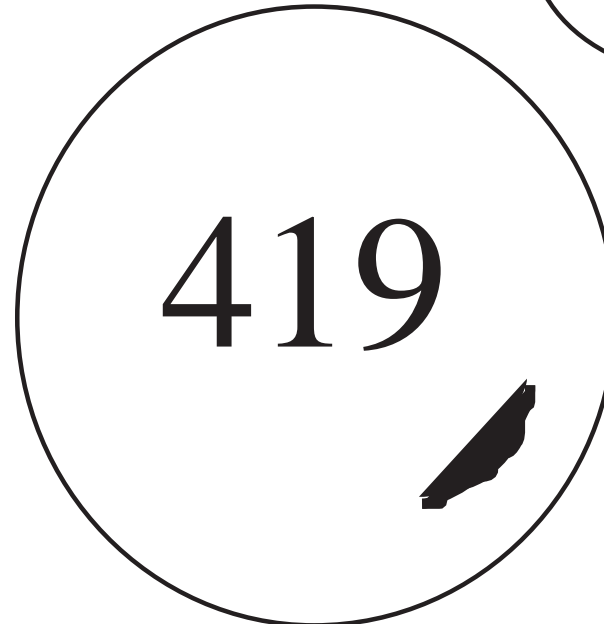
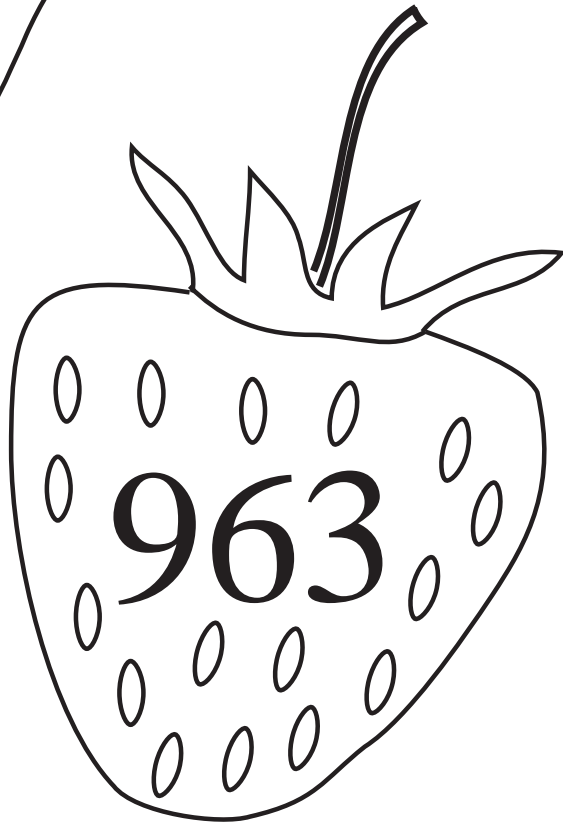
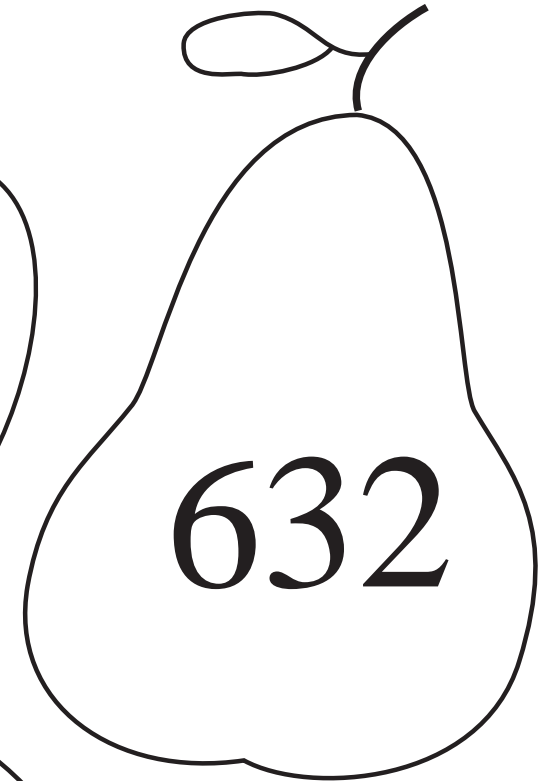
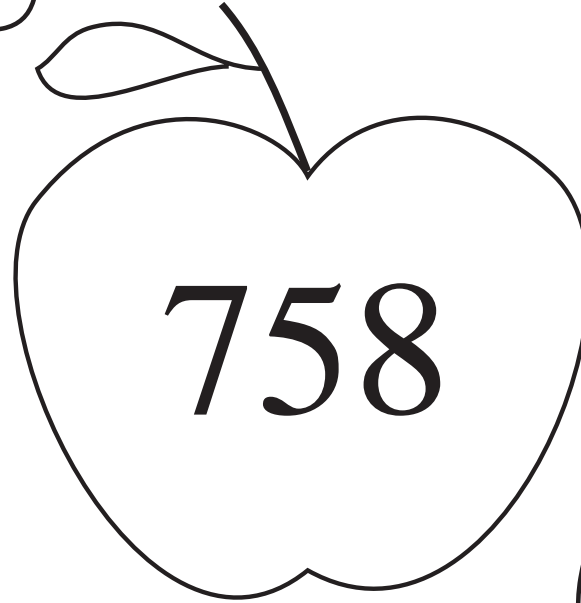

a)

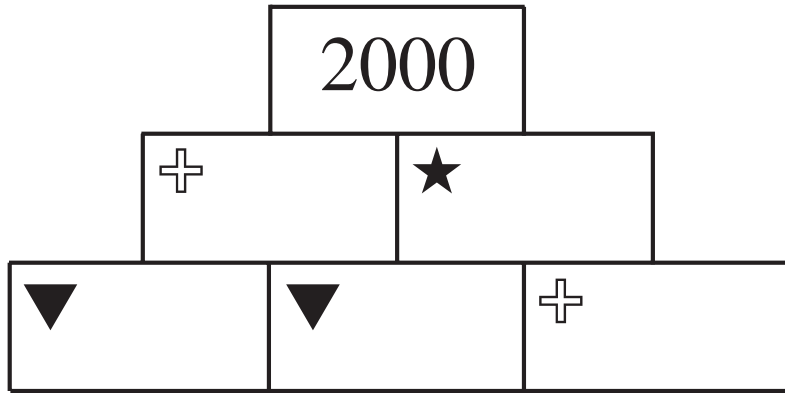

b)

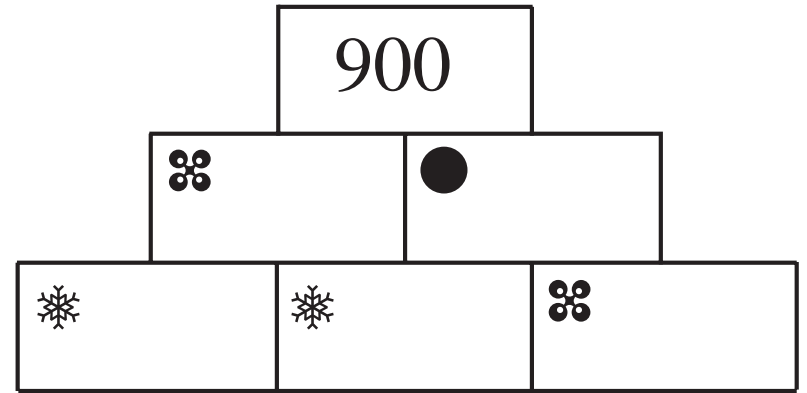

LP104/6

a)

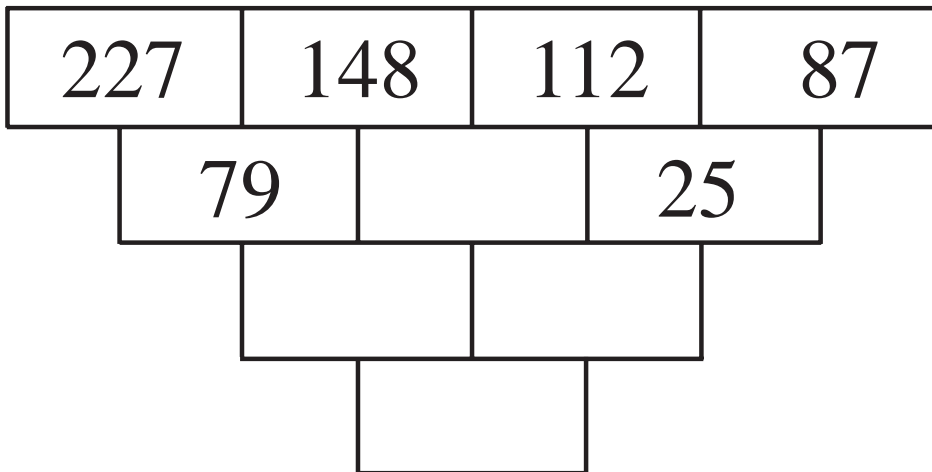

b)

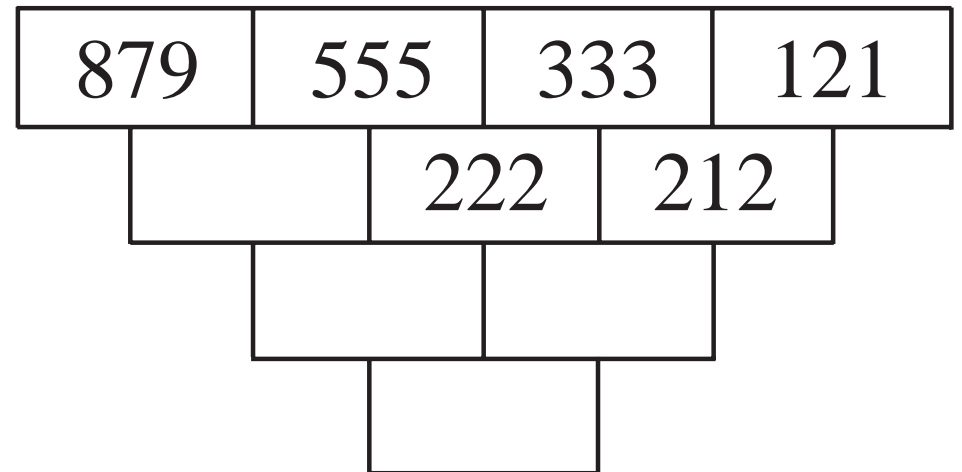

LP104/7

i)  $589 + \boxed{a} = 832$   
 $a =$  .....

ii)  $645 - \boxed{d} = 331$   
 $d =$  .....

iii)  $\boxed{g} - 375 = 412$   
 $g =$  .....

$589 + \boxed{b} > 832$   
 $b :$  .....

$645 - \boxed{e} \geq 331$   
 $e :$  .....

$\boxed{h} - 375 < 412$   
 $h :$  .....

$589 + \boxed{c} \leq 832$   
 $c :$  .....

$645 - \boxed{f} < 331$   
 $f :$  .....

$\boxed{i} - 375 > 412$   
 $i :$  .....

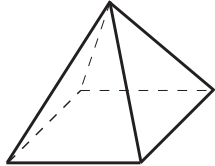
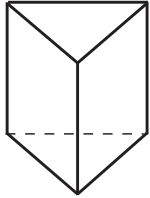
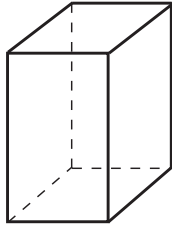
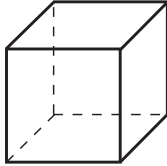
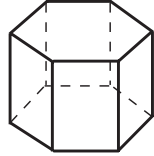
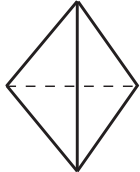
	Square-based pyramid	Triangle-based prism	Cuboid	Cube	Hexagonal prism	Triangle-based pyramid
						
Faces						
Vertices						
Edges						

LP 106/6

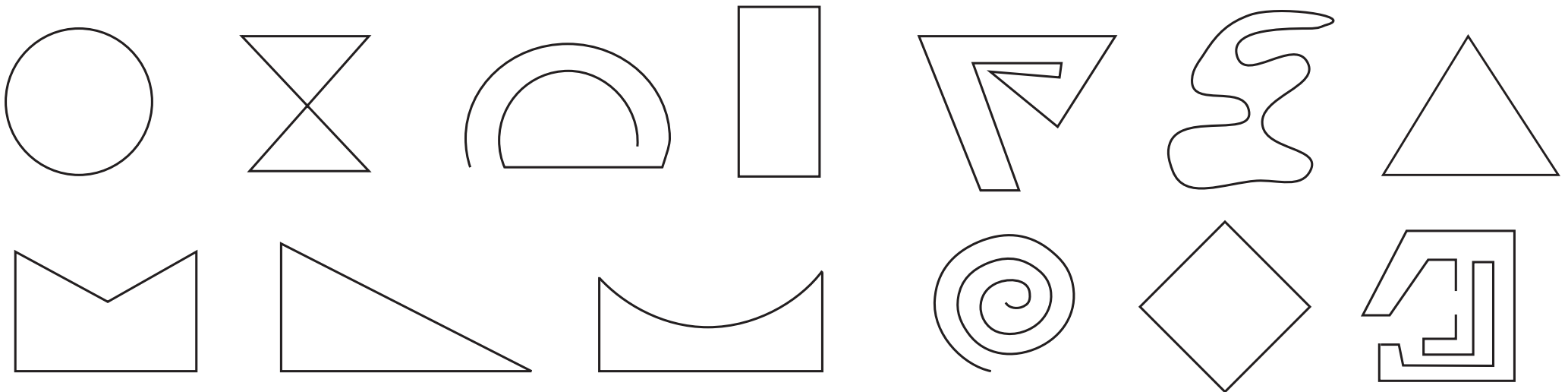

LP 106/8

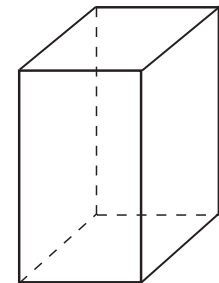
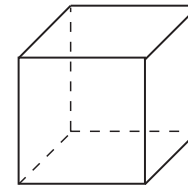
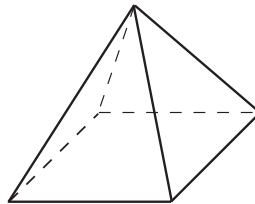
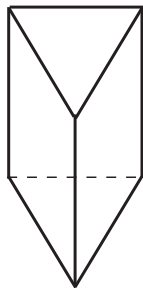
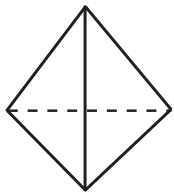
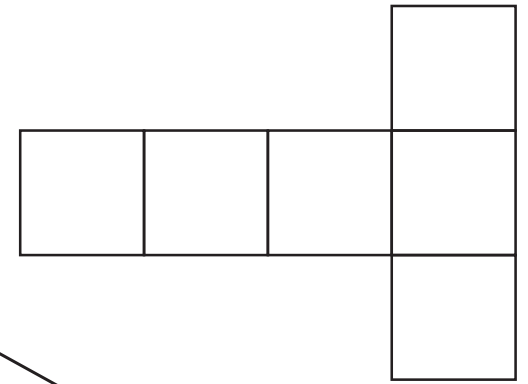
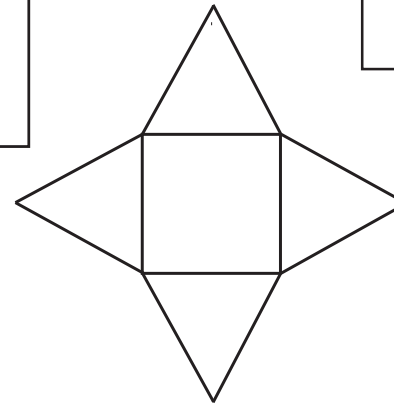
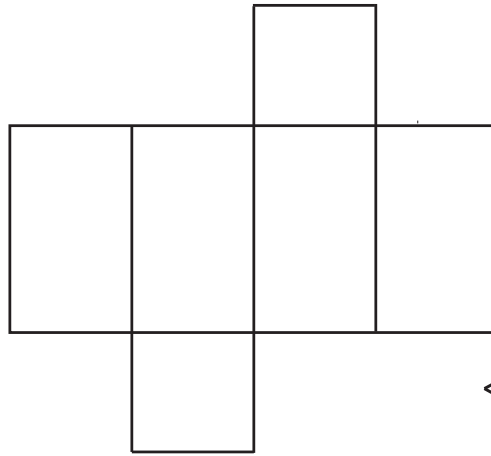
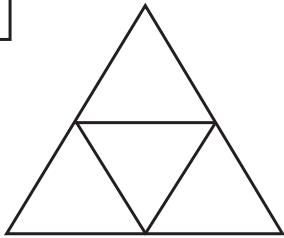
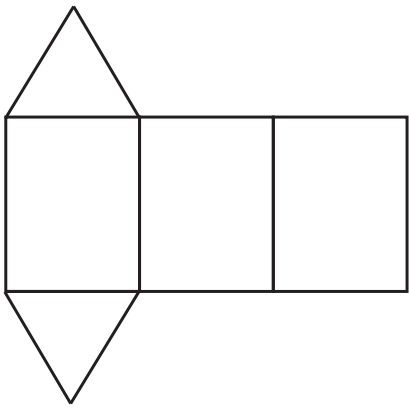



1 cm measuring grid

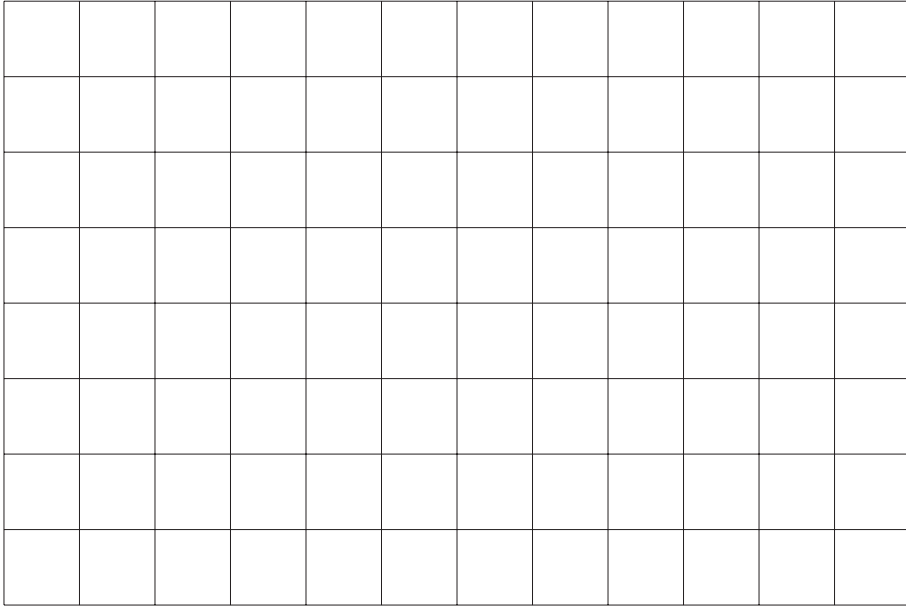

1 cm measuring grid

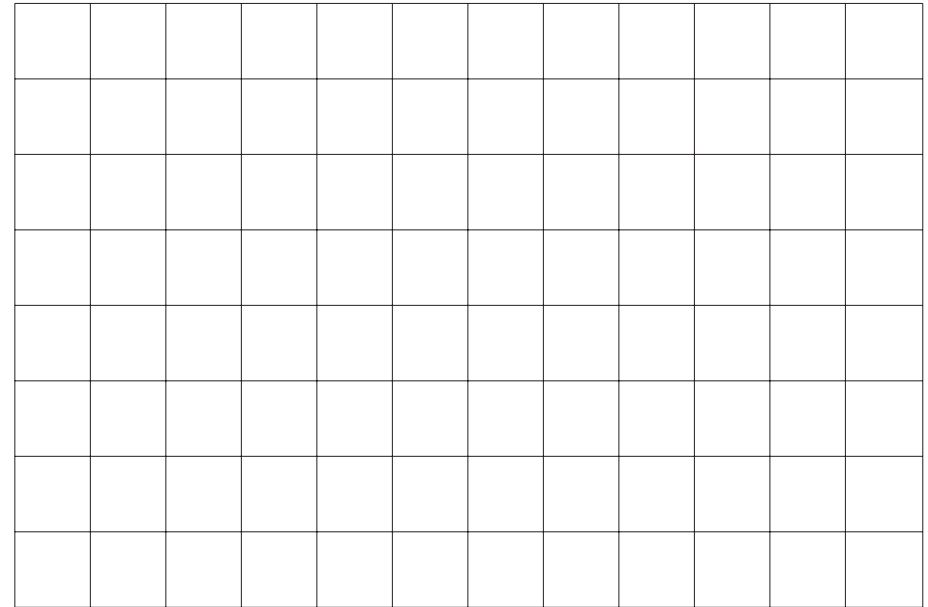

0.5 cm measuring grid

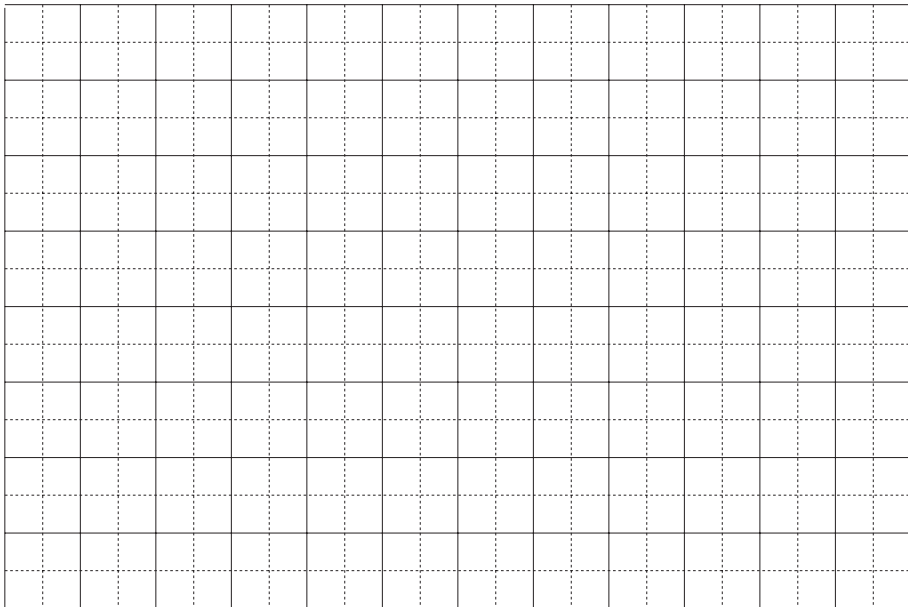

0.5 cm measuring grid

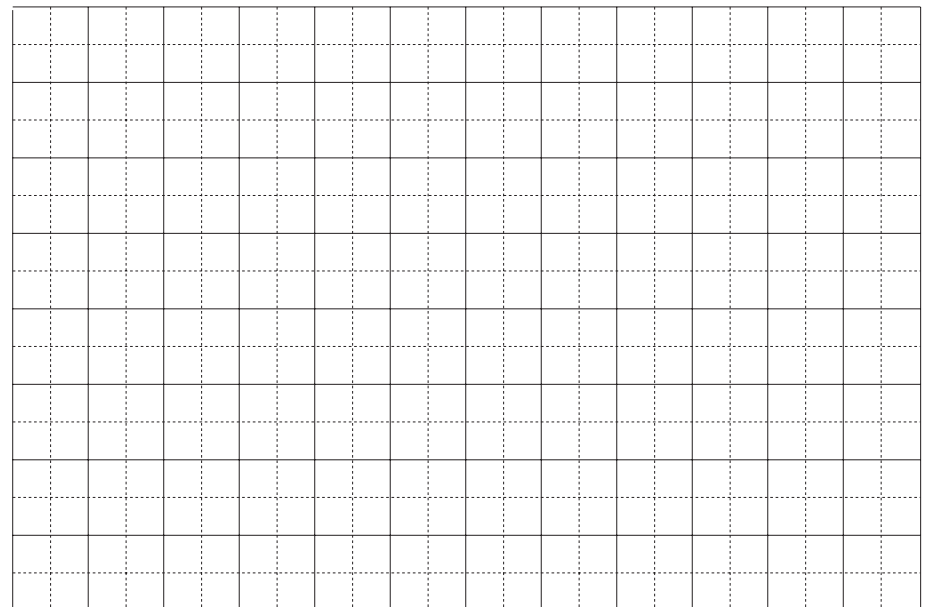





1 cm drawing grid

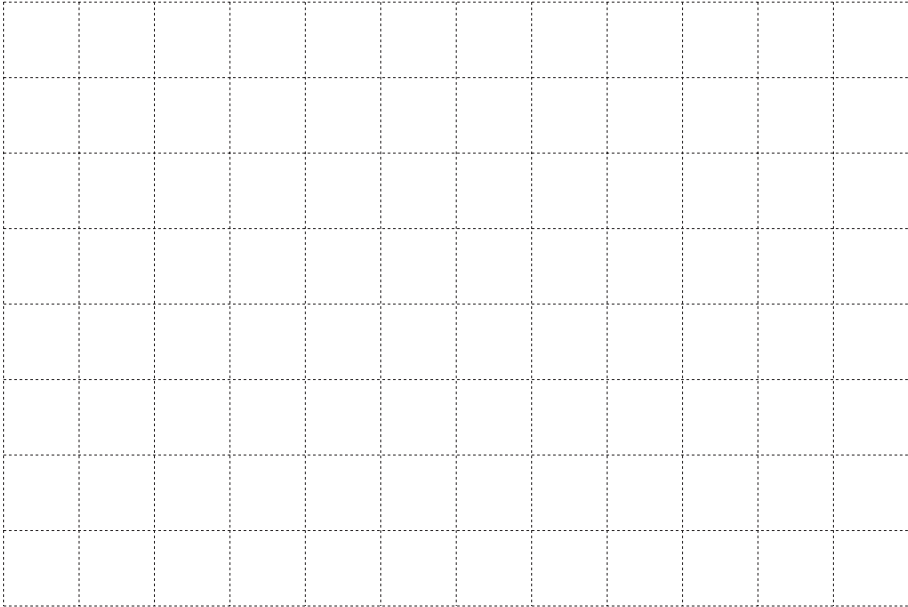

1 cm drawing grid

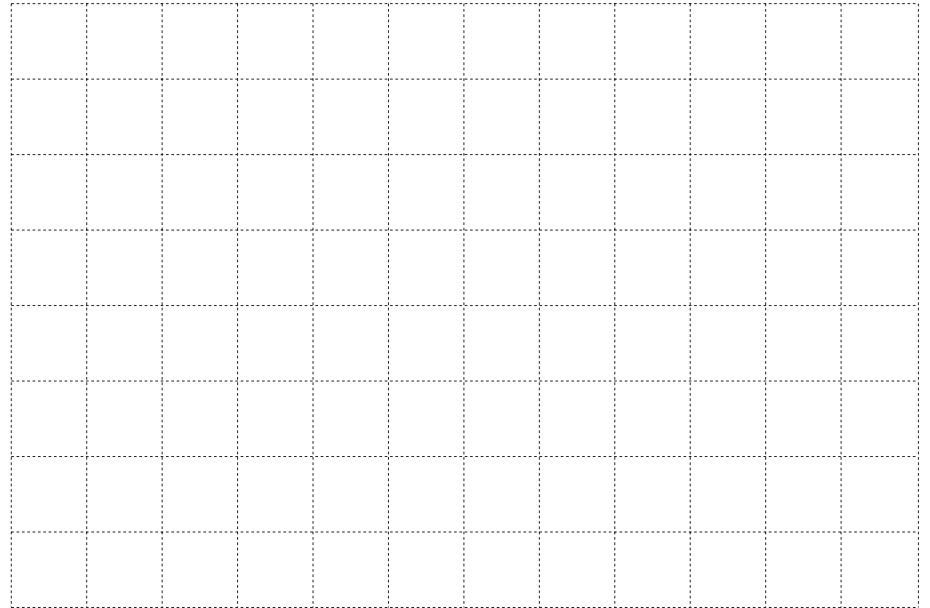

0.5 cm drawing grid

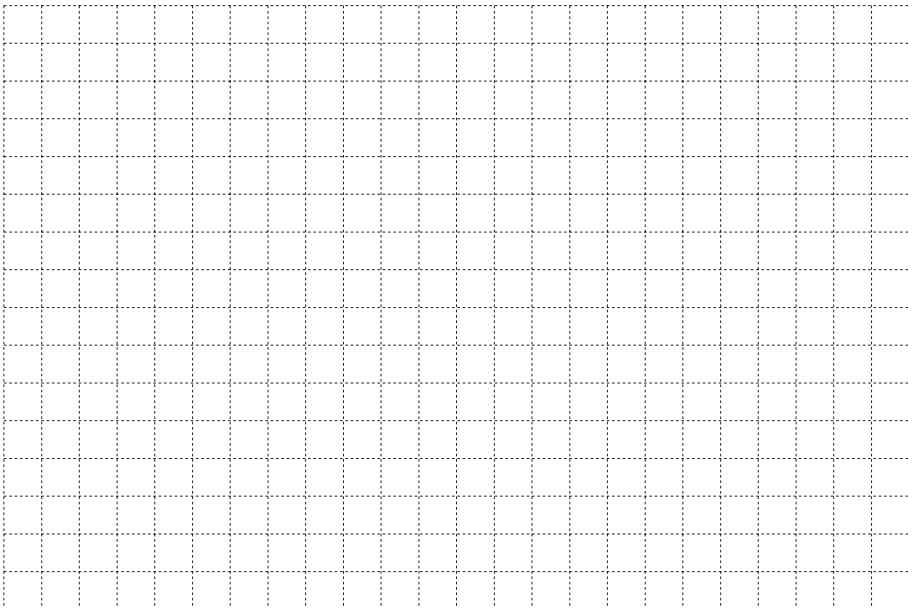

0.5 cm drawing grid

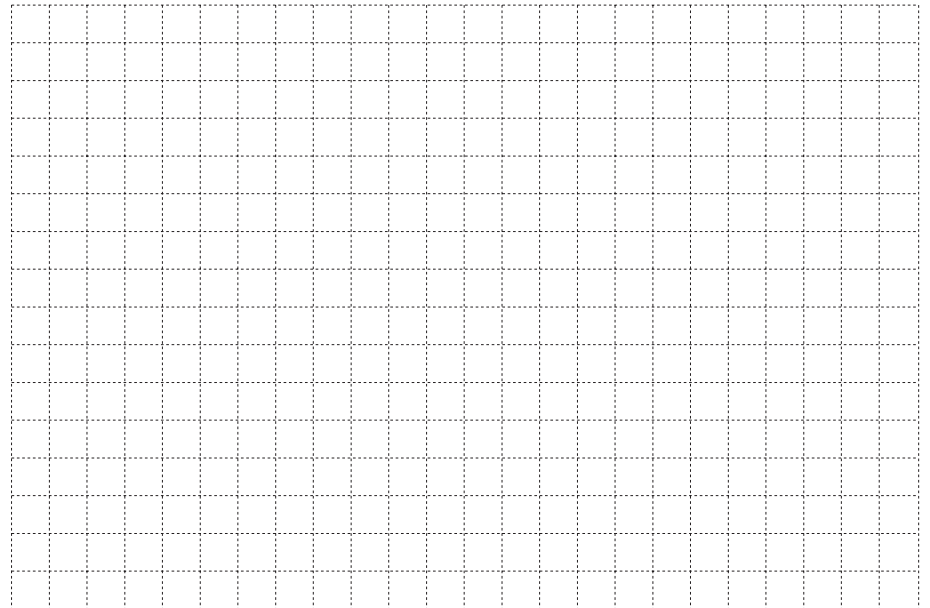

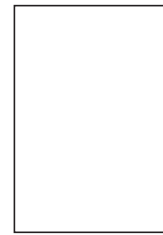
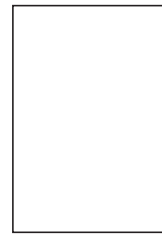
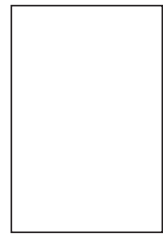
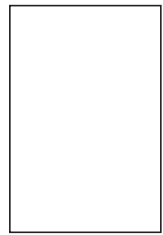
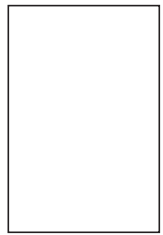
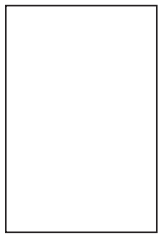
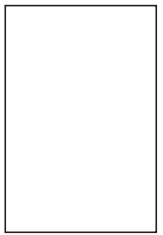
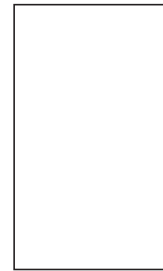
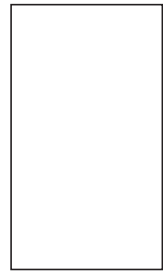
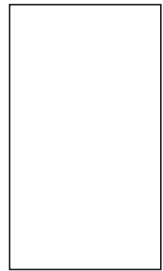
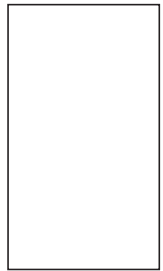
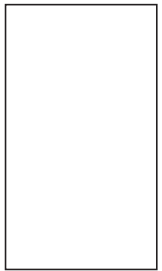
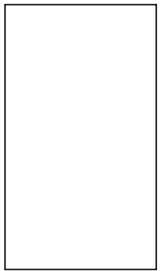
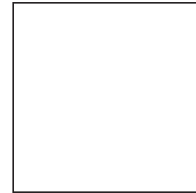
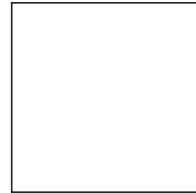
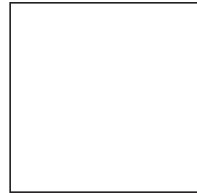
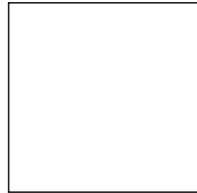
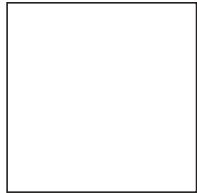
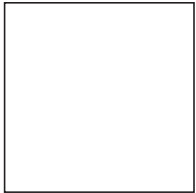
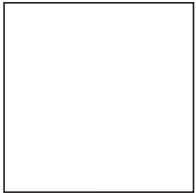
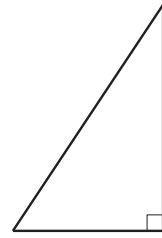
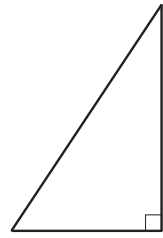
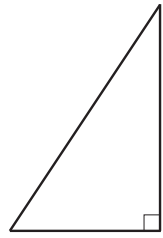
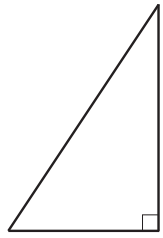
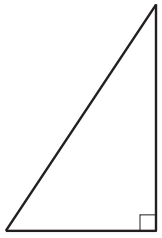
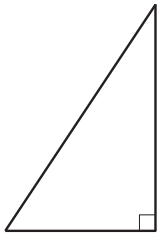



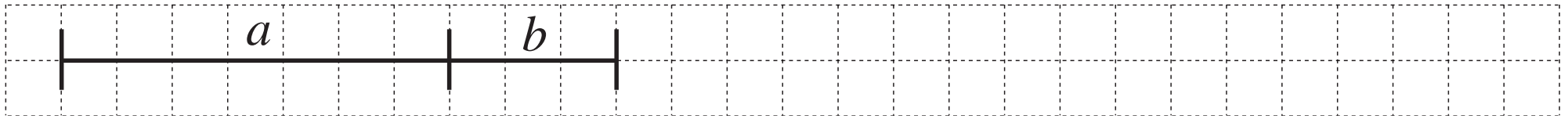
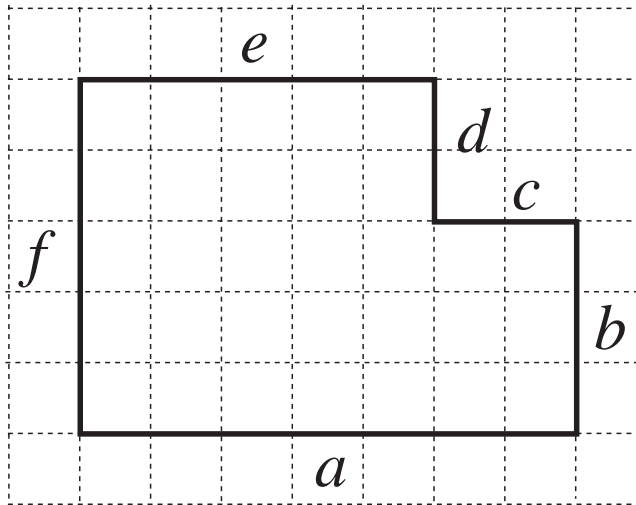

Copy so that each P has 1 column



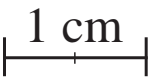

- a) If the unit used is , then Perimeter =  
- b) If the unit used is , then Perimeter =  cm
- c) If the unit used is , then Perimeter =  

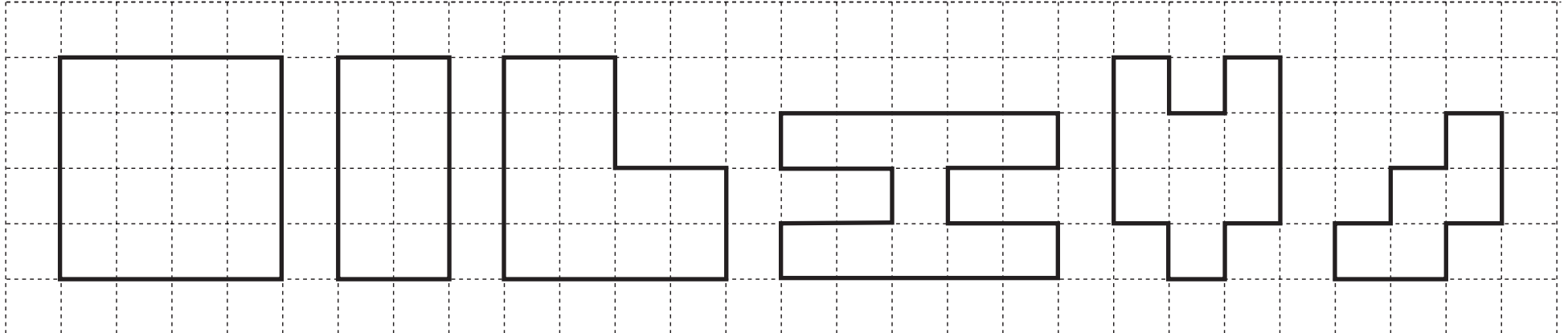

$P$ ┌───┐	16					
$A$ □		8				

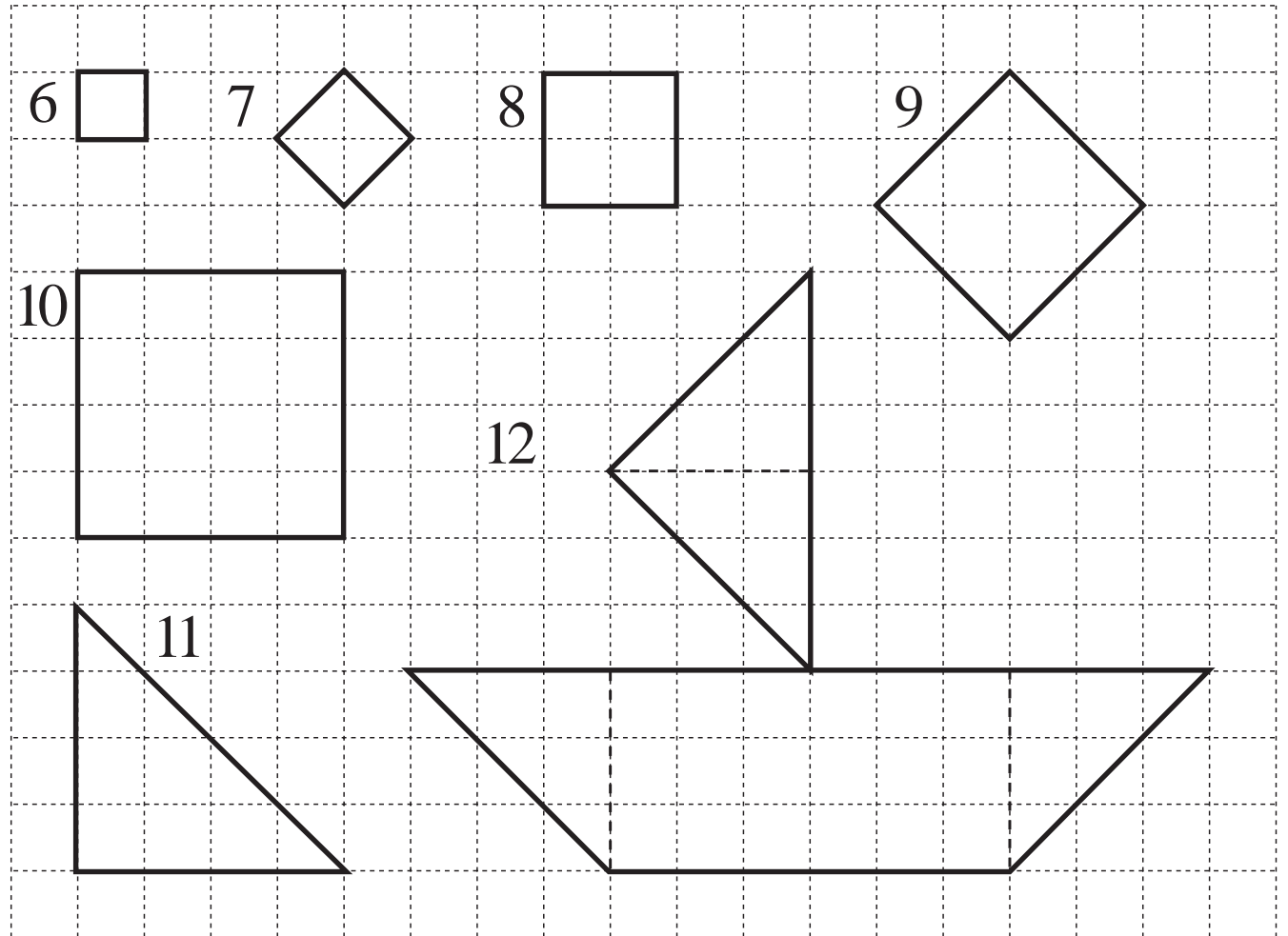
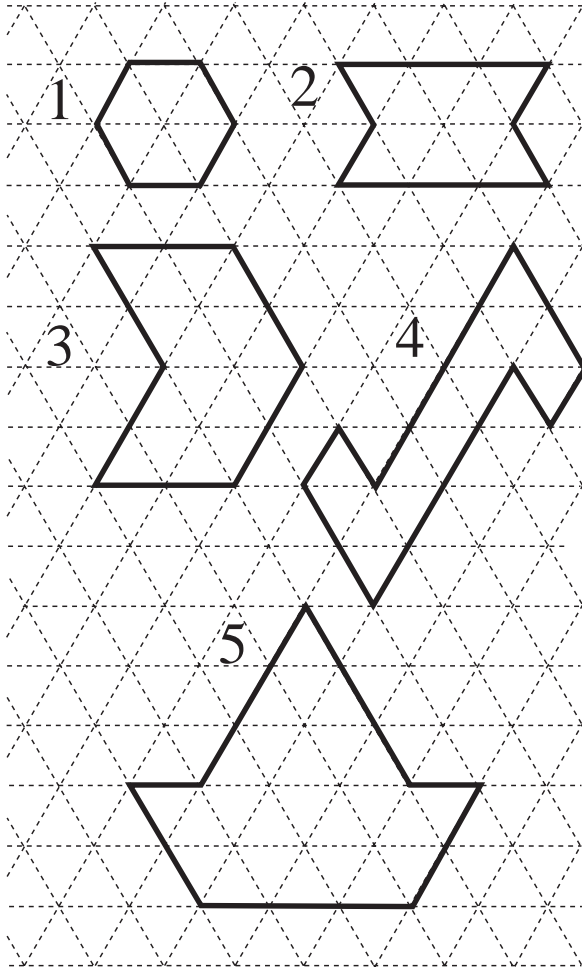

<i>a</i>	300	160	235	400	230			1406	473	547
<i>b</i>	200	620	340			326	162		254	
<i>c</i>	500	780		1000	850	859	795	1996		943

LP 108/1

<i>a</i>	700	670	835	1365	1453			1675	555	320
<i>b</i>	200	150	210	1132	343	375	518		268	
<i>c</i>	500	520				415	1111	455		147

LP 109/2

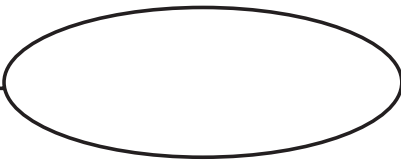
Low 

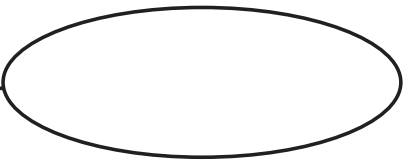
Small 

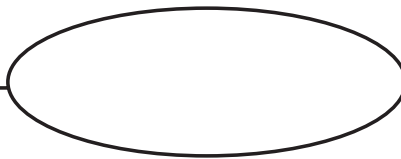
Under 

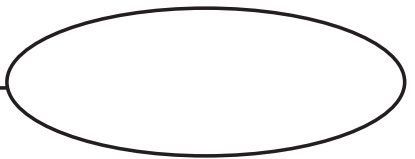
Less 

Right 

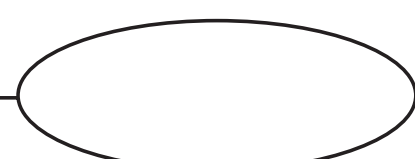
Front 

Up 

Thick 

Blackboard

Teacher's desk



*Column 1*

*Row 1*



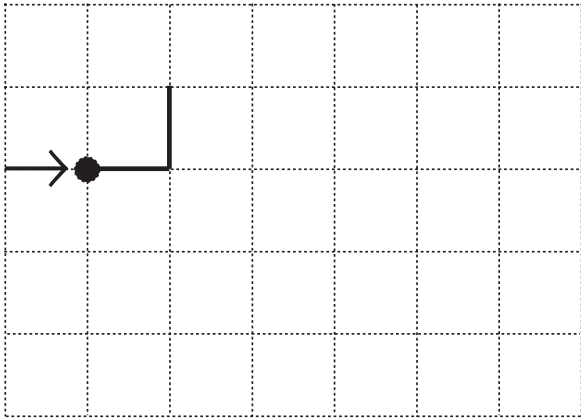

a)

 $P =$  $A =$ 

b)

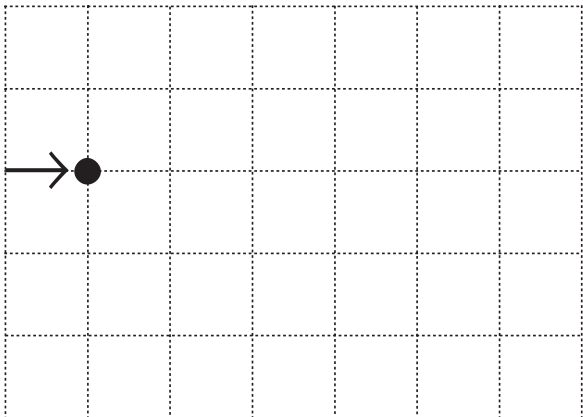
 $P =$  $A =$ 

c)

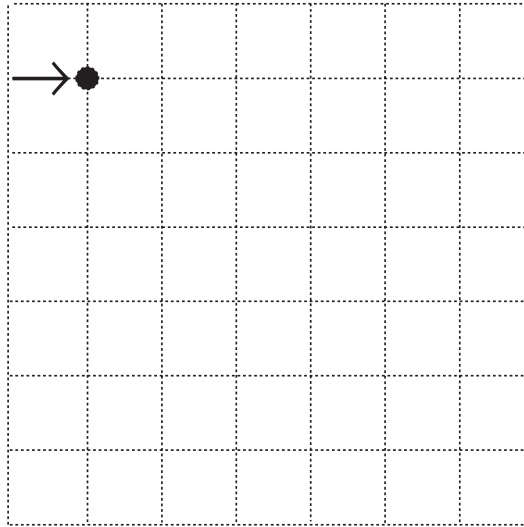
 $P =$  $A =$ 

d)

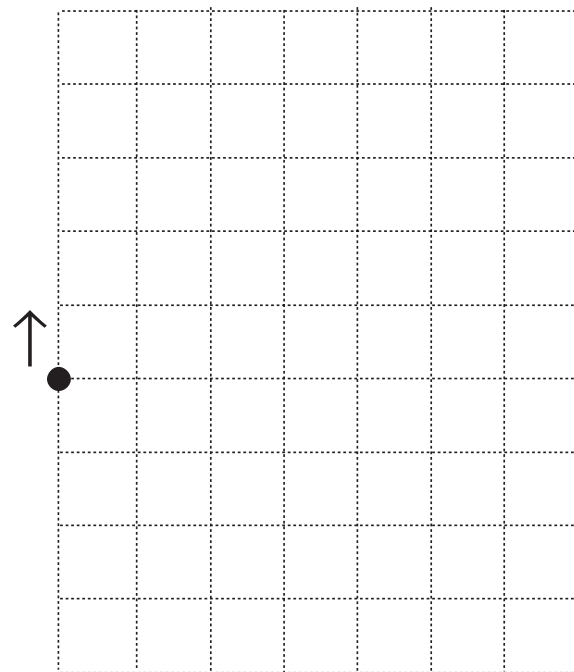

U1,

 $P =$  $A =$

East

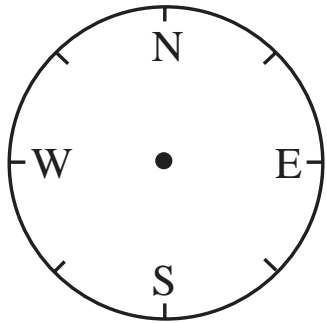

South

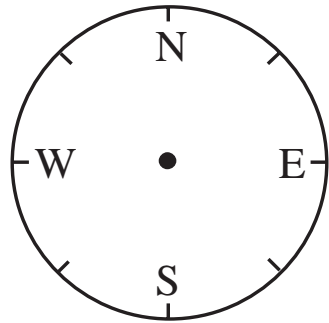

South-West

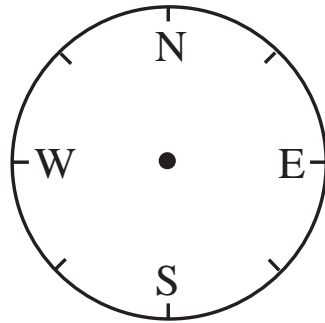

North-East

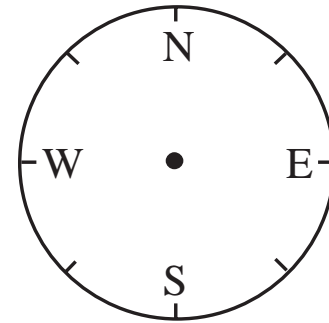

North-West

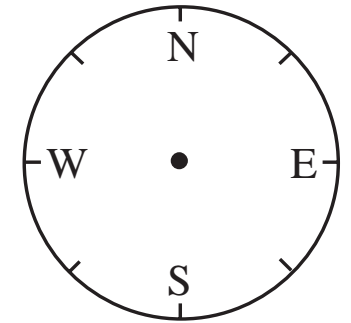

LP 109/5

a)

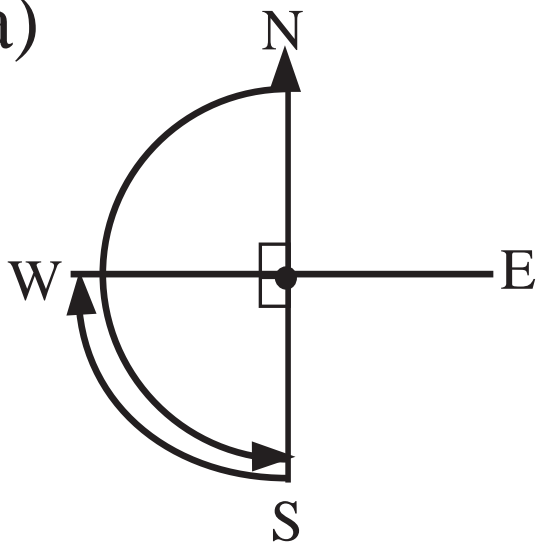

b)

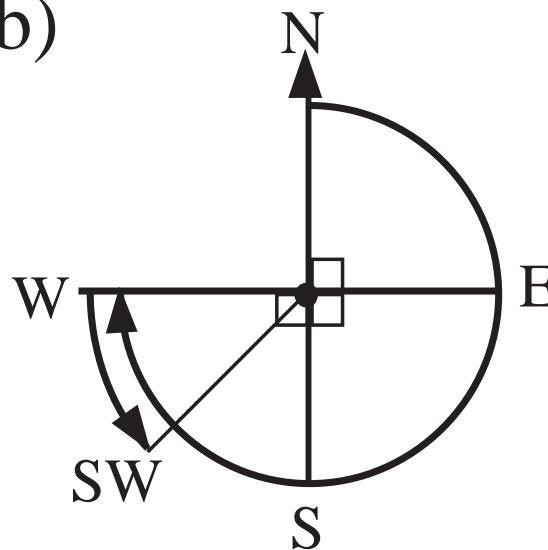

c)

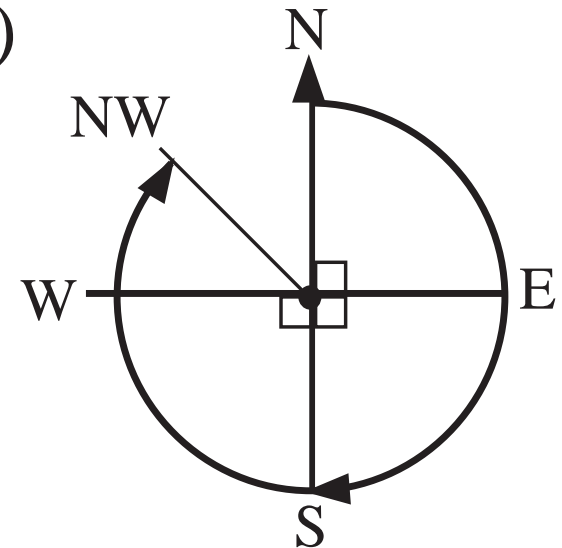

LP 109/6

a)

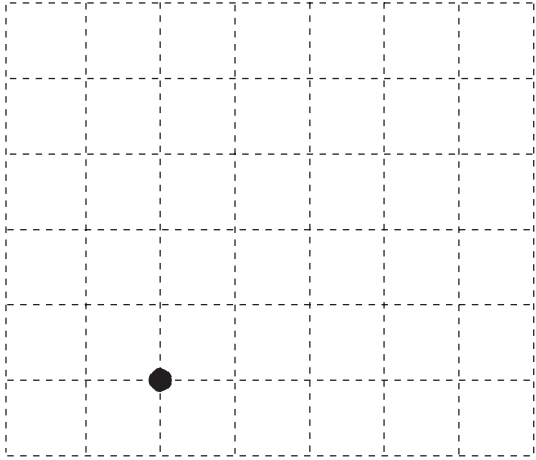

b)

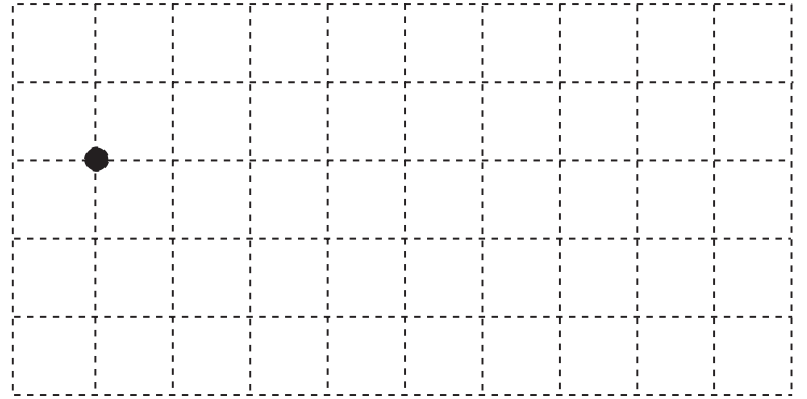

c)

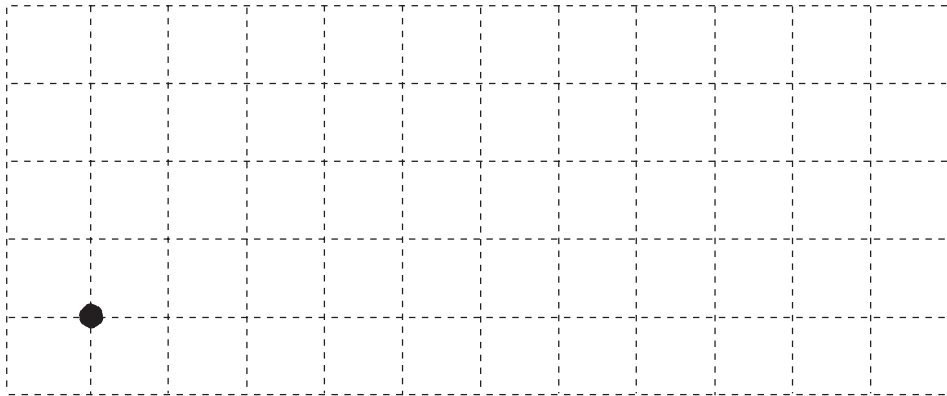

d)



i)  $690 + \boxed{a} = 943$   
 $a = \dots\dots\dots$

ii)  $865 - \boxed{d} = 553$   
 $d = \dots\dots\dots$

iii)  $\boxed{g} - 597 = 634$   
 $g = \dots\dots\dots$

$300 + \boxed{b} < 412 - 99$   
 $b : \dots\dots\dots$

$865 - \boxed{e} \geq 442$   
 $e : \dots\dots\dots$

$\boxed{h} - 486 < 523$   
 $h : \dots\dots\dots$

$456 + \boxed{c} = 832$   
 $c = \dots\dots\dots$

$865 - \boxed{f} < 442$   
 $f : \dots\dots\dots$

$\boxed{i} - 486 > 523$   
 $i : \dots\dots\dots$