

a)

	1	3	0	8	7
-		1	3	0	8

b)

	4	2	8	.	3
-		6	0	.	2

c)

	4	7	5	2
			×	4

d)

	4	4	4
	×	2	1

e)

	6	5	1	.	2	8
	2	0	7	.	4	3
+	1	0	4	0	.	0
		9	9	.	9	9

f)

8	1	7	2	5	3

g)

1	7	1	9	6	0	5

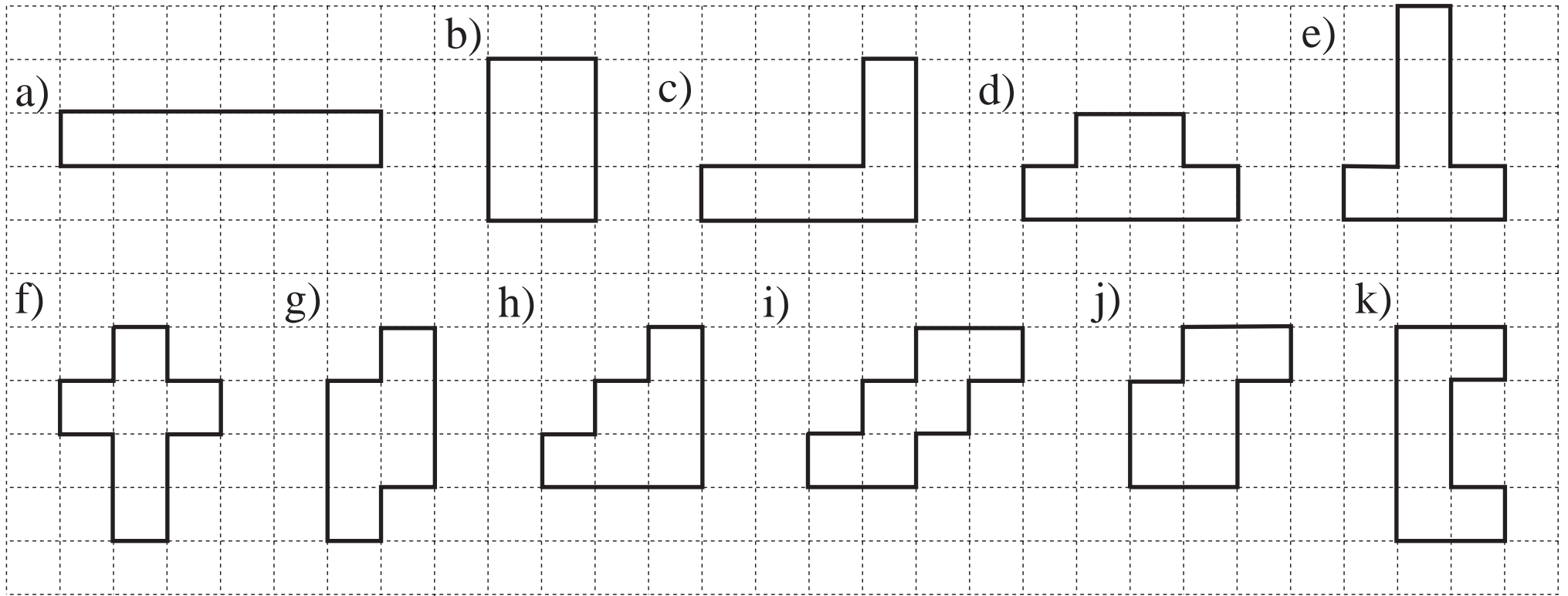

LP 141/4

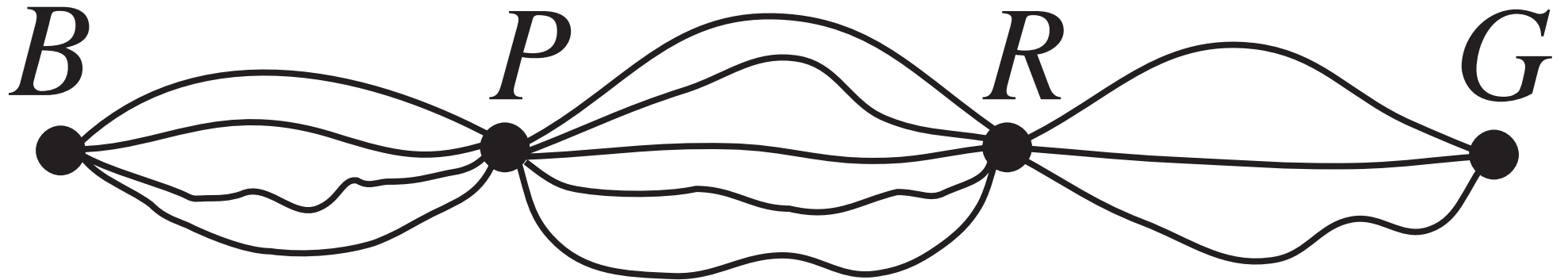

LP 141/8

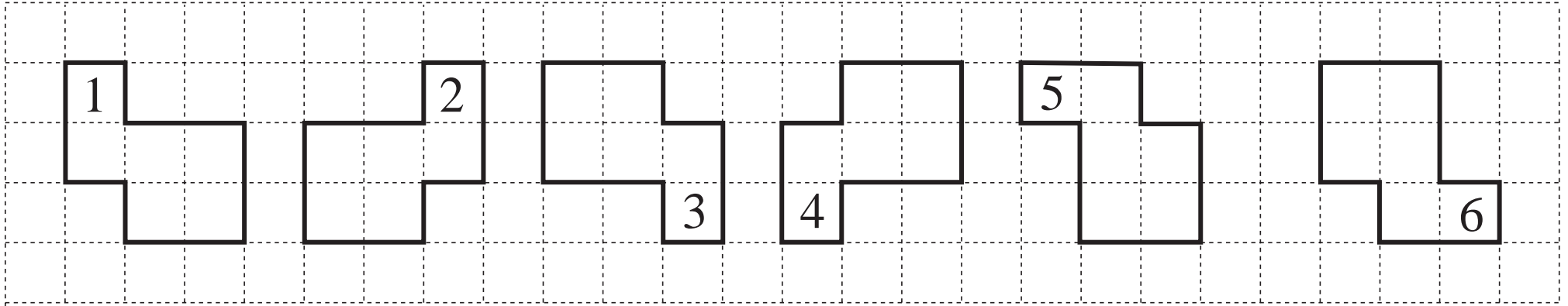

LP 141/5

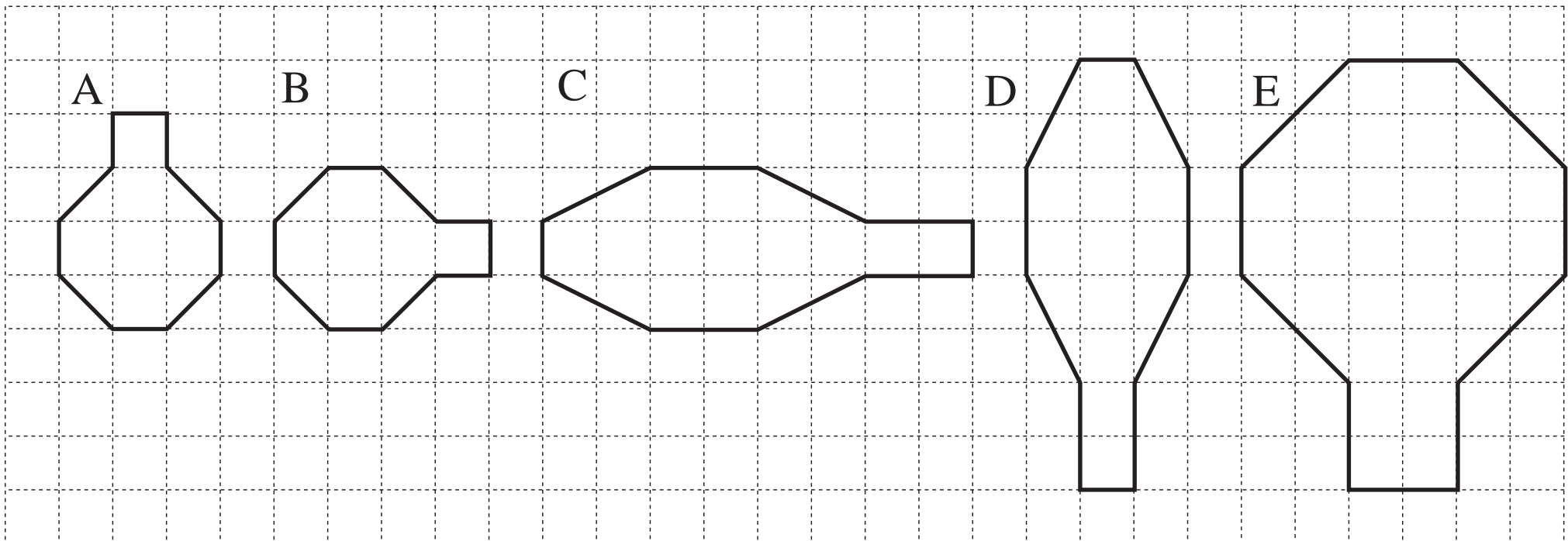

LP 141/6

A

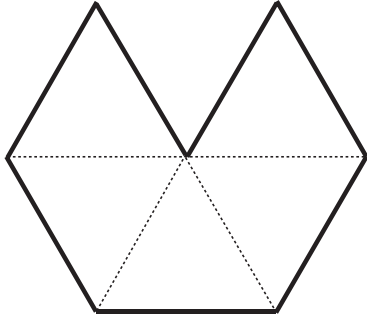

B

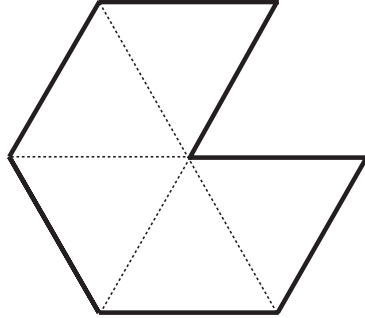

C

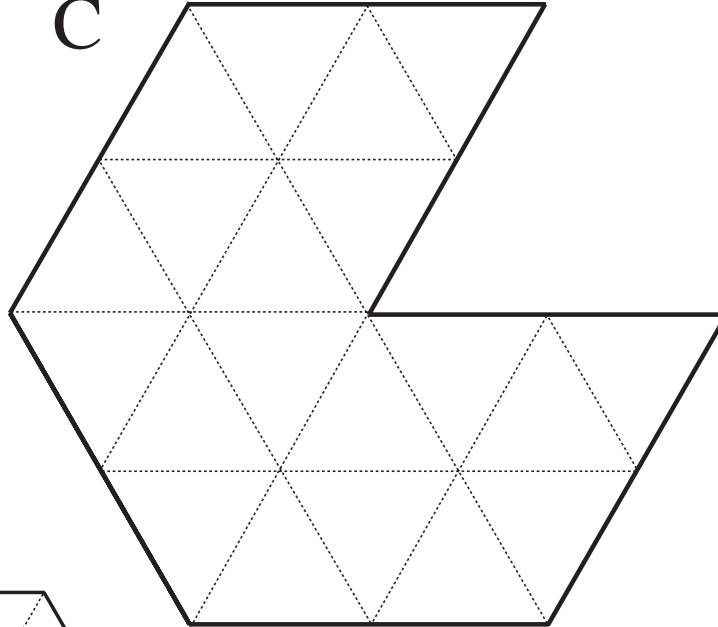

D

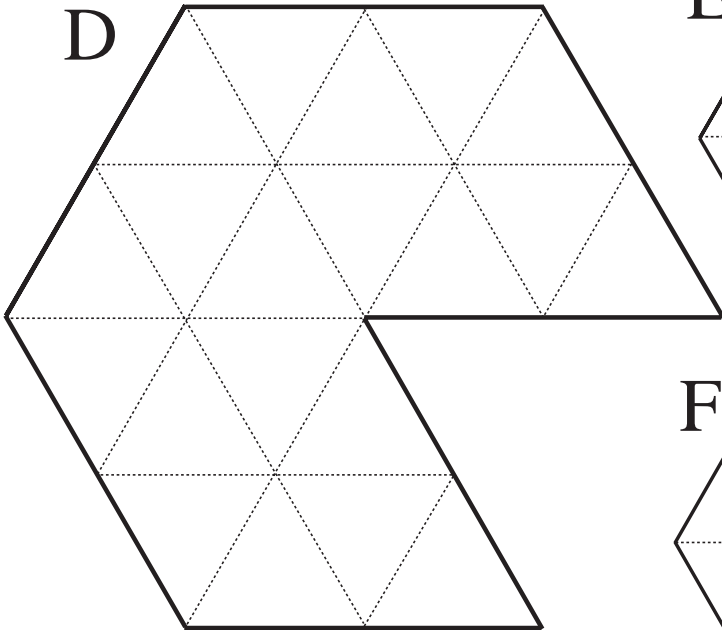

E

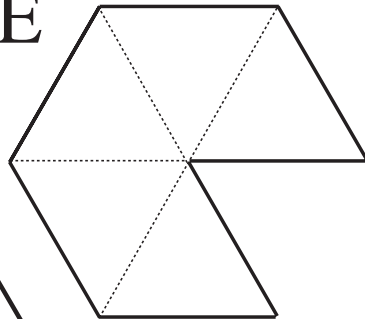

G

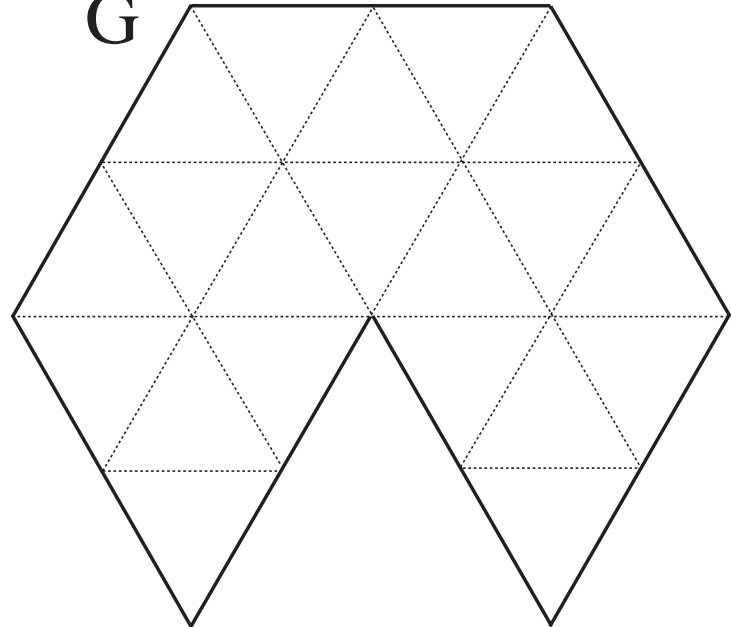

F

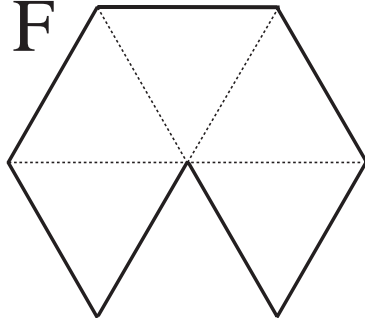

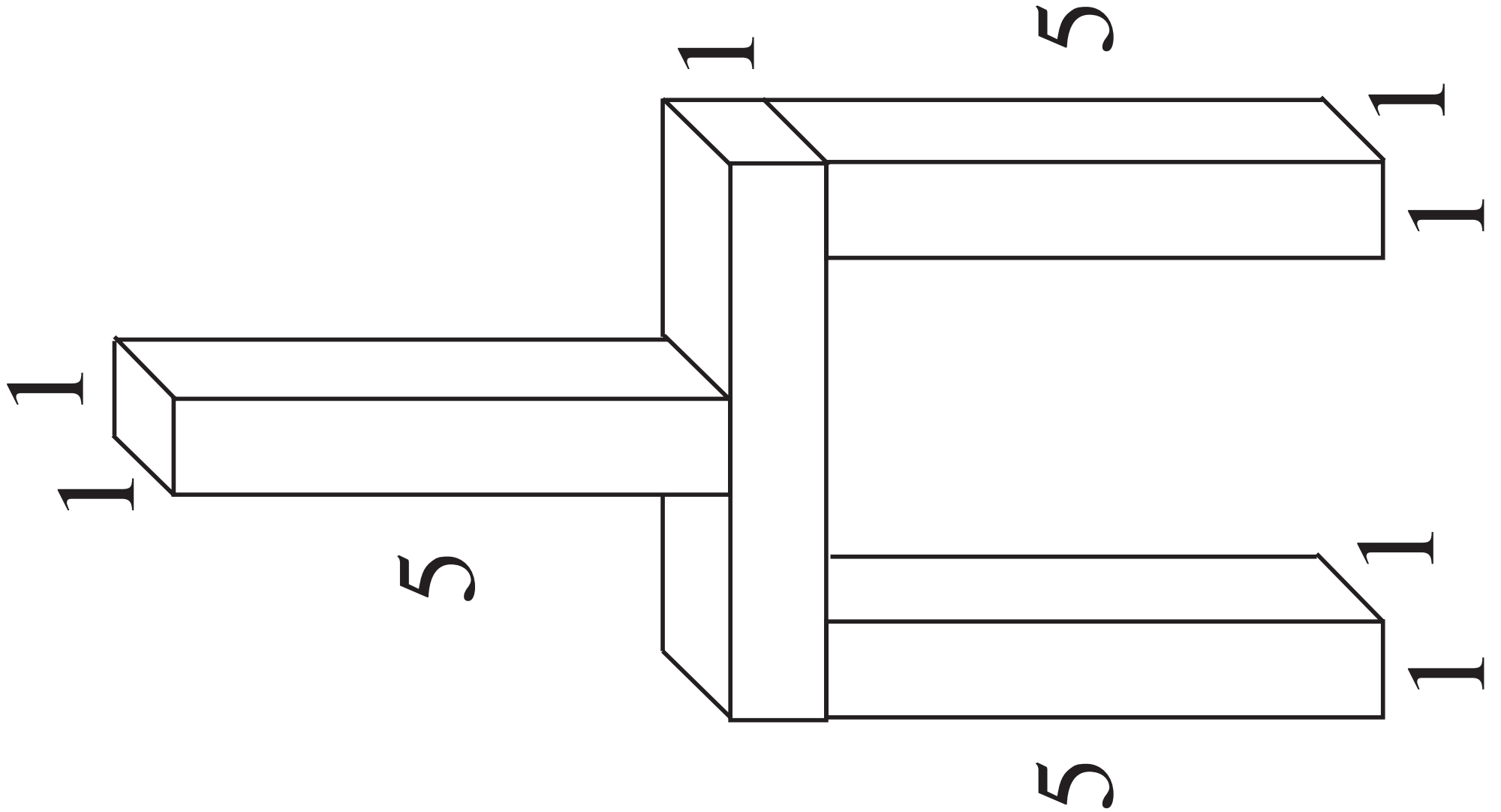

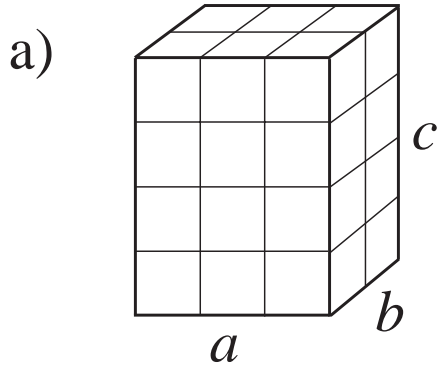

$$a = 3 \text{ units}$$

$$b = 2 \text{ units}$$

$$c = 4 \text{ units}$$

.....

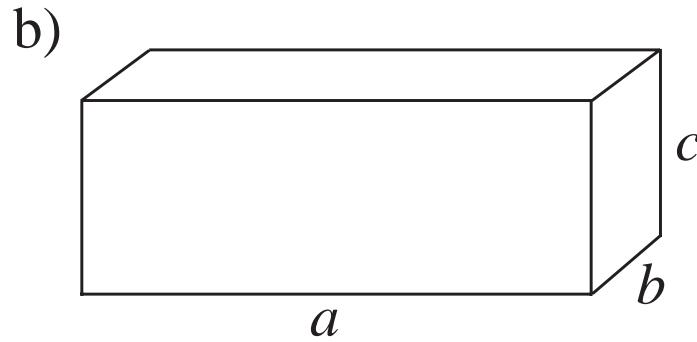

$$a = 8 \text{ units}$$

$$b = 2 \text{ units}$$

$$c = 8 \text{ units}$$

.....

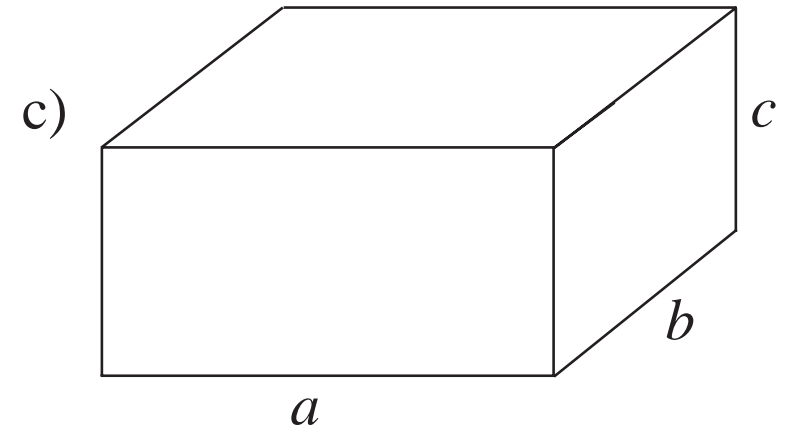

$$a = 6 \text{ units}$$

$$b = 4 \text{ units}$$

$$c = 8 \text{ units}$$

.....

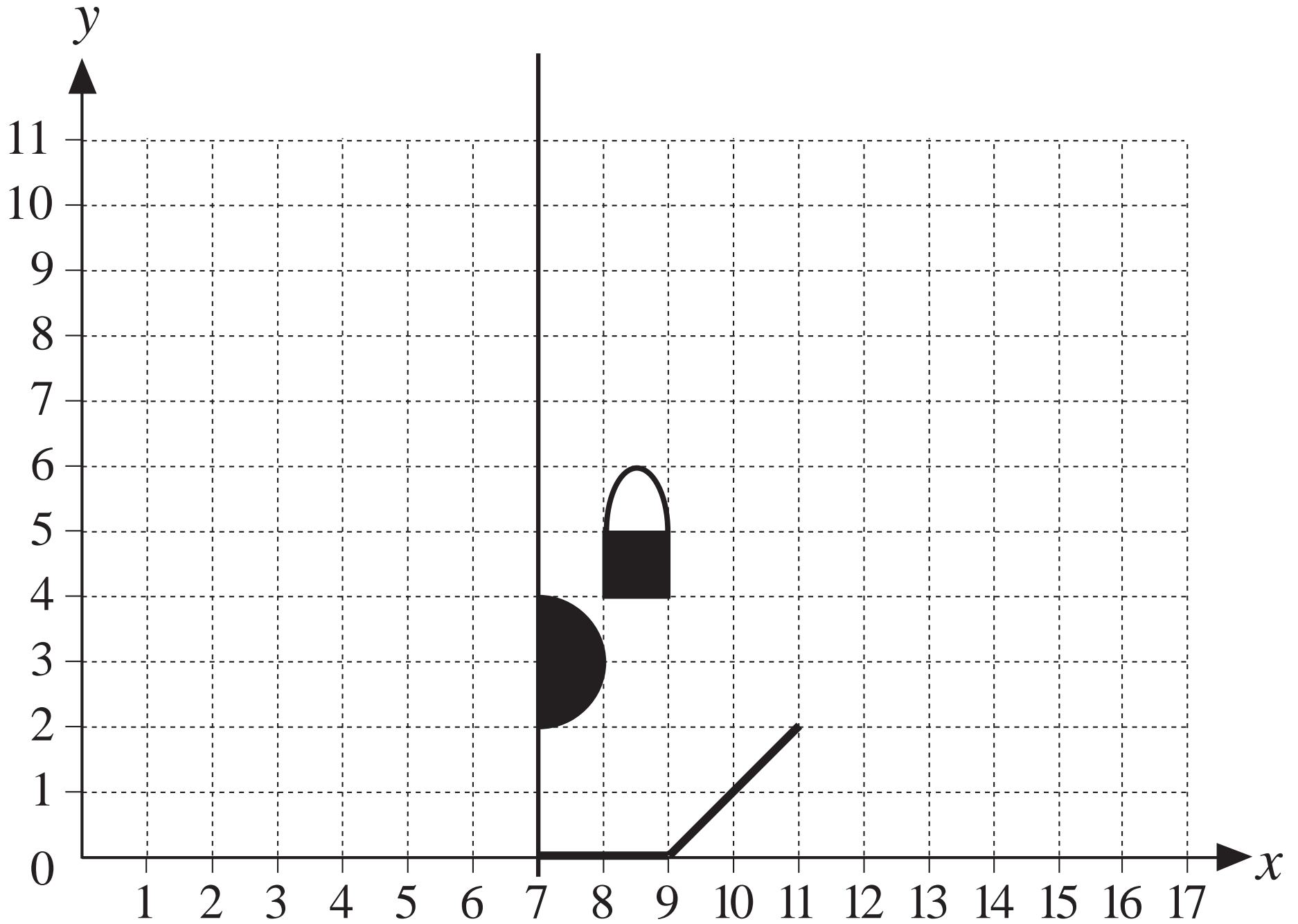

a)

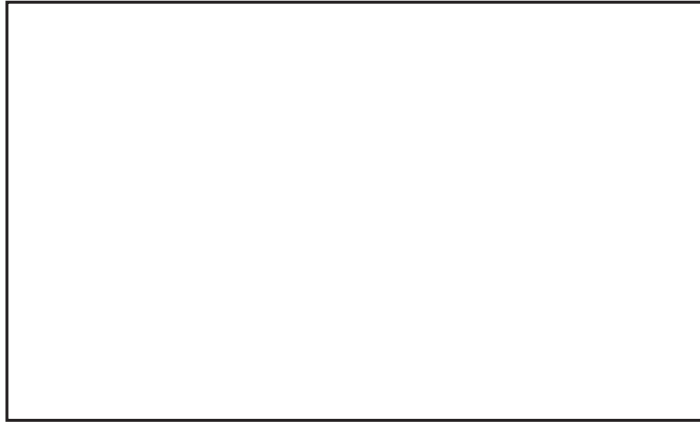

$$P = \text{.....}$$

$$A = \text{.....}$$

b)

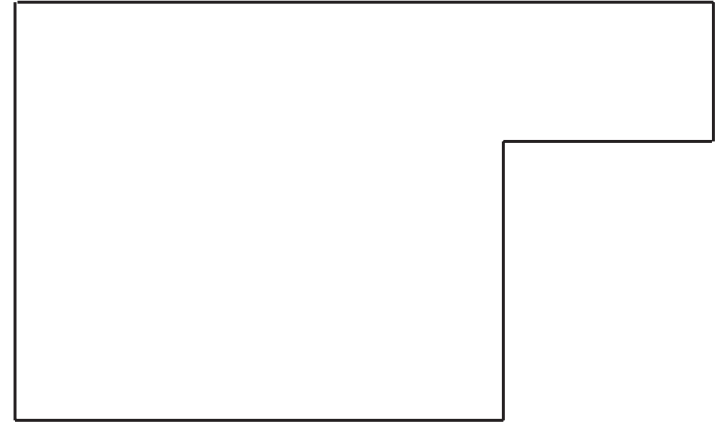

$$P = \text{.....}$$

$$A = \text{.....}$$



a)

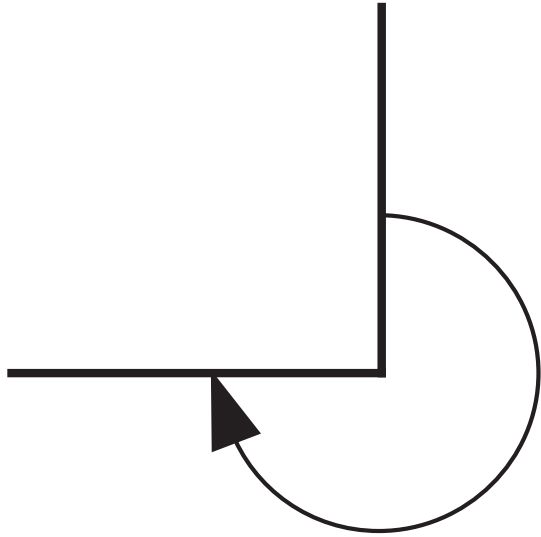

b)

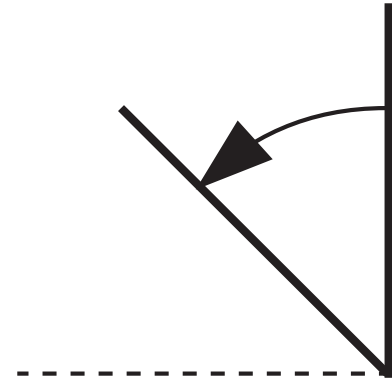

c)

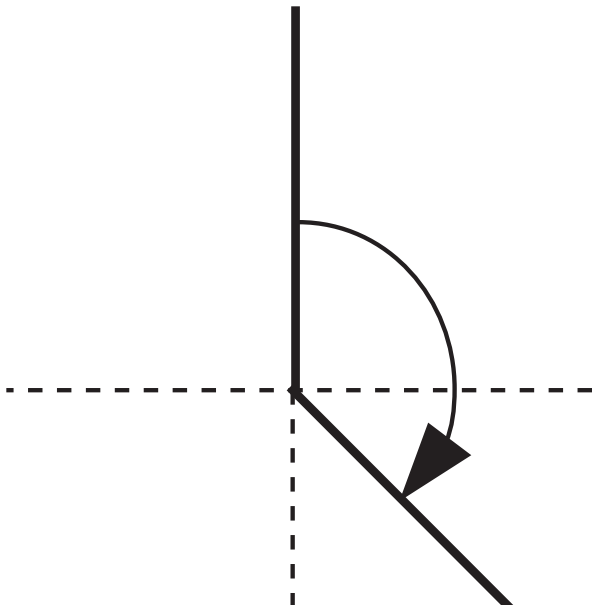

d)

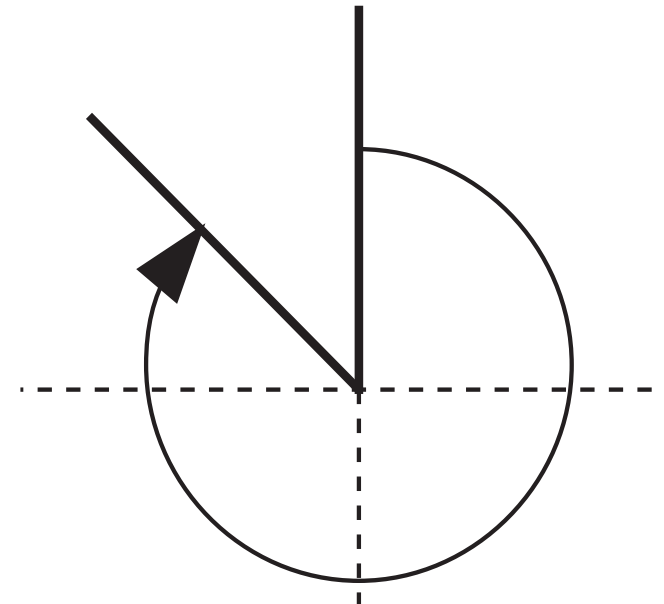

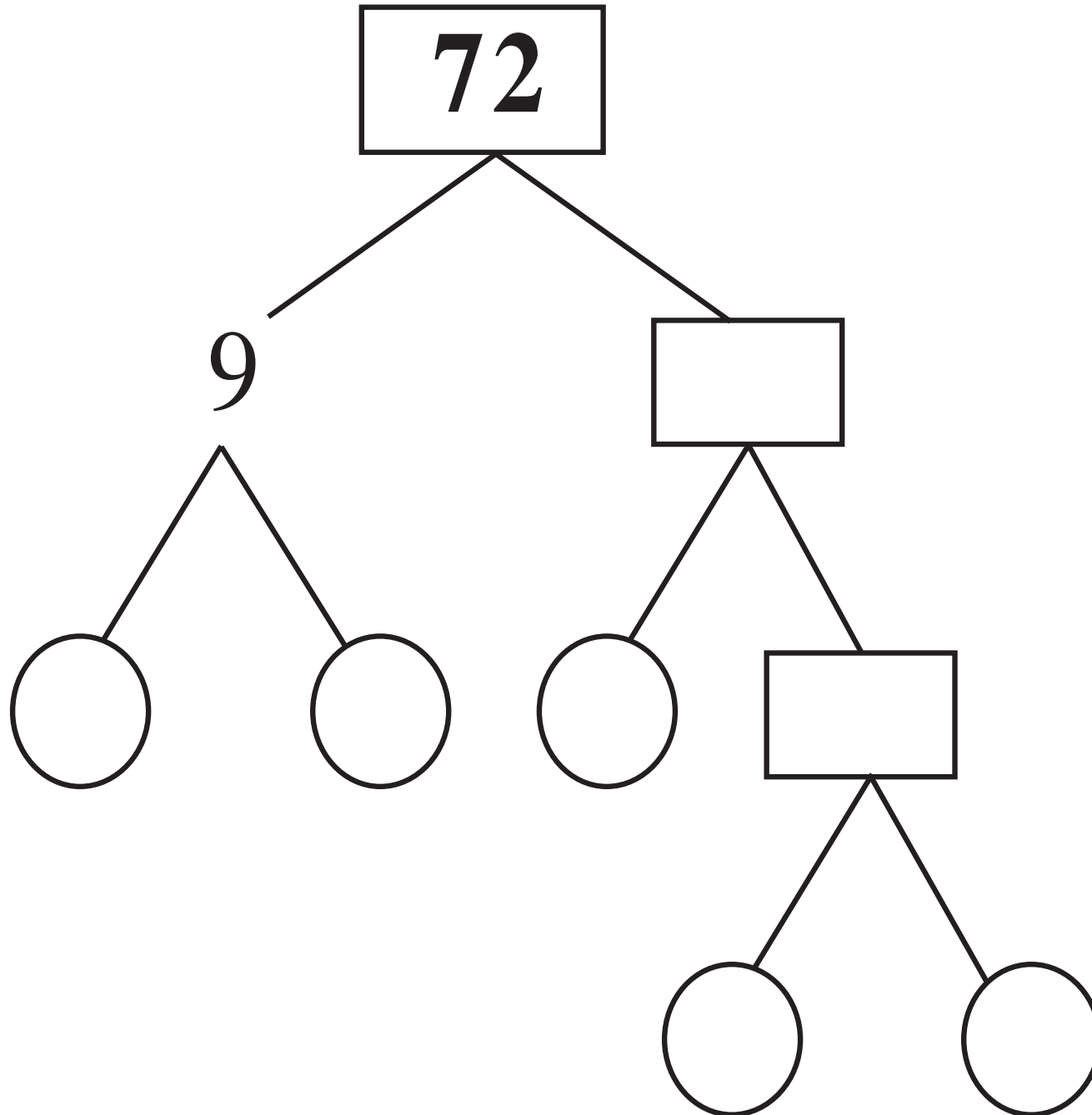

<i>a</i>	1	1	1									
<i>b</i>	1	2	3									
<i>c</i>	72											

LP 143/7b

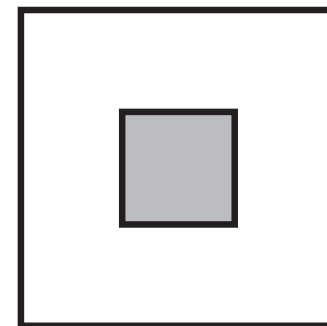
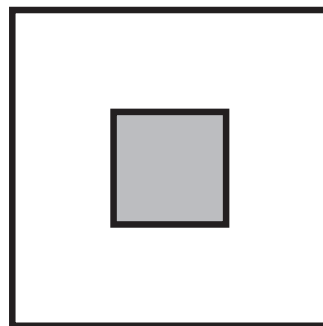
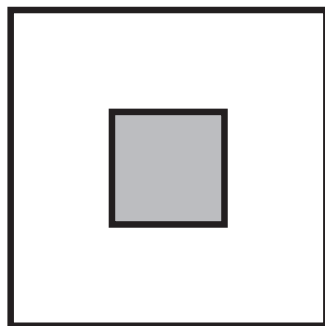
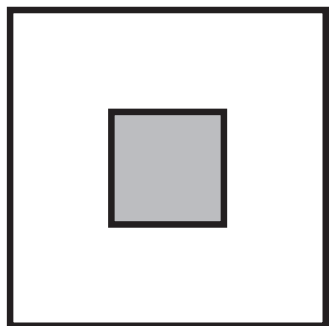

LP 144/4

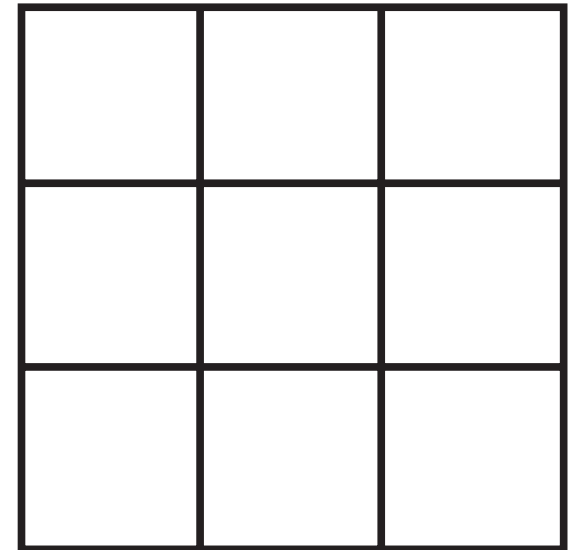
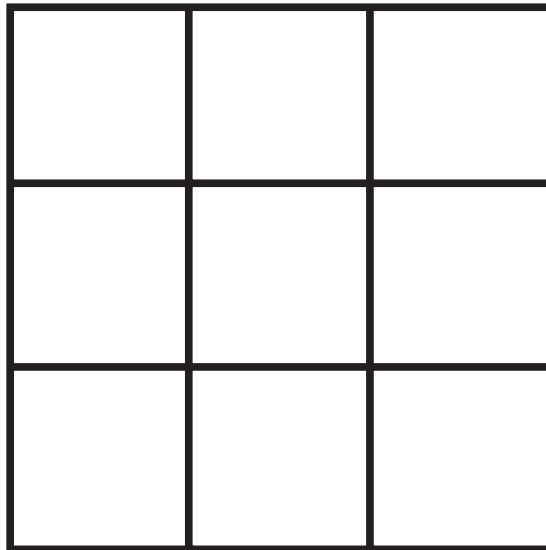
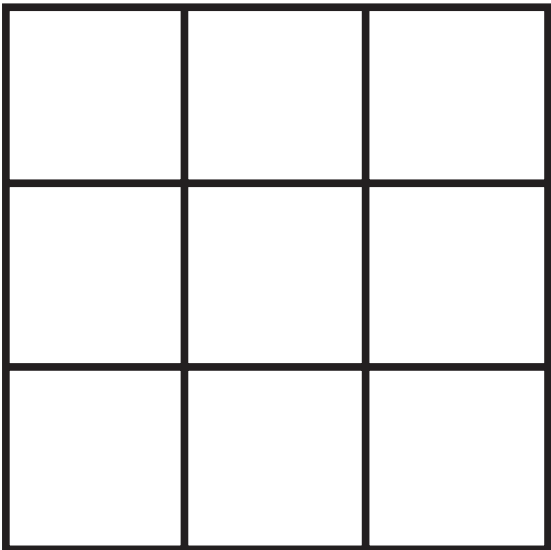
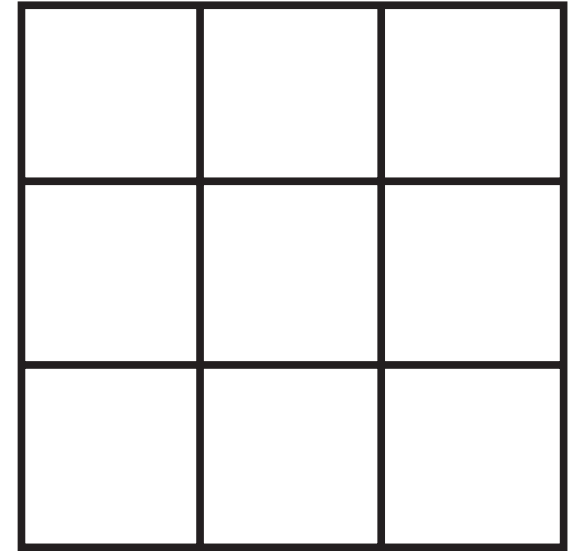
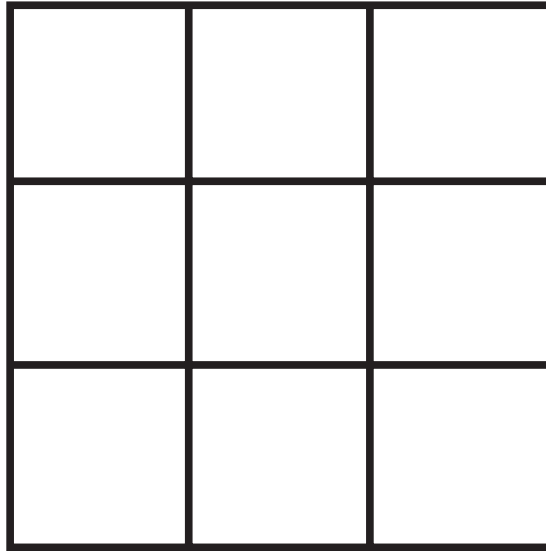
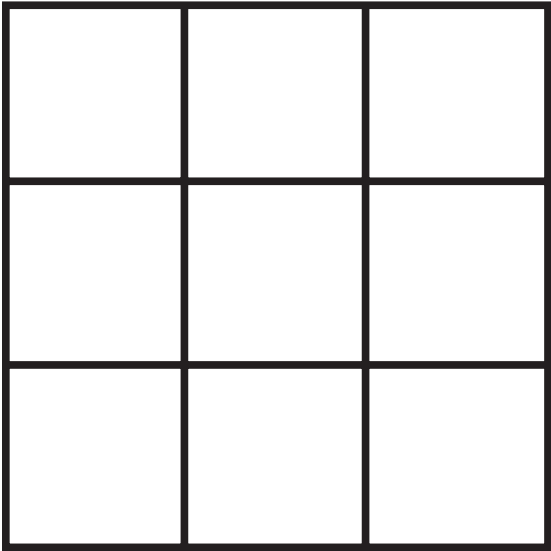

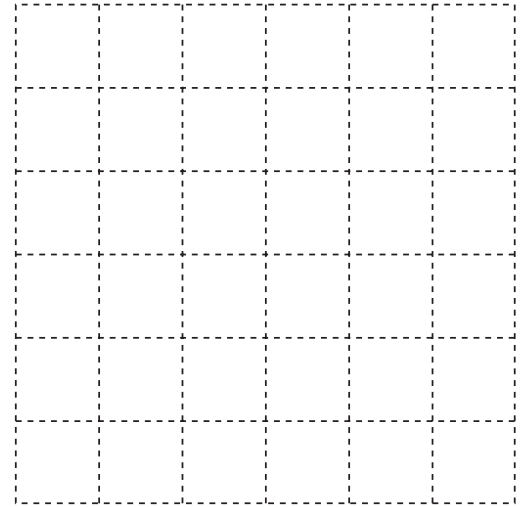
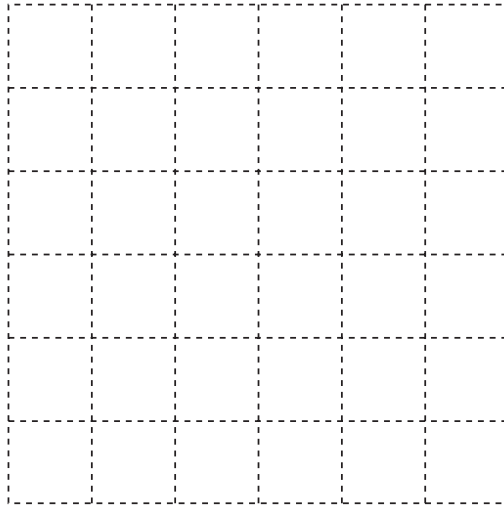
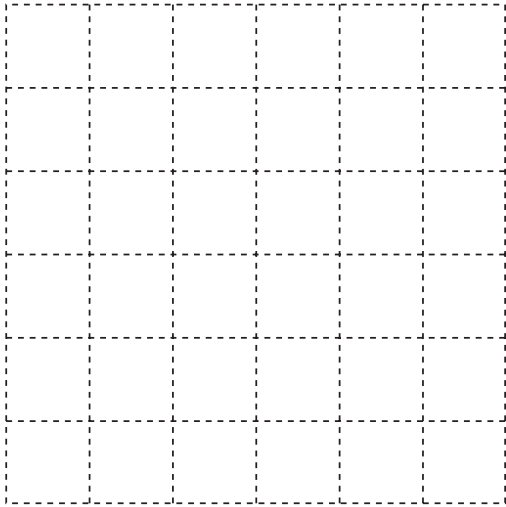
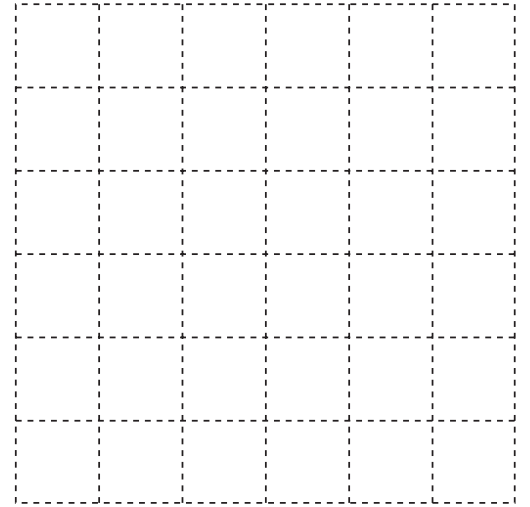
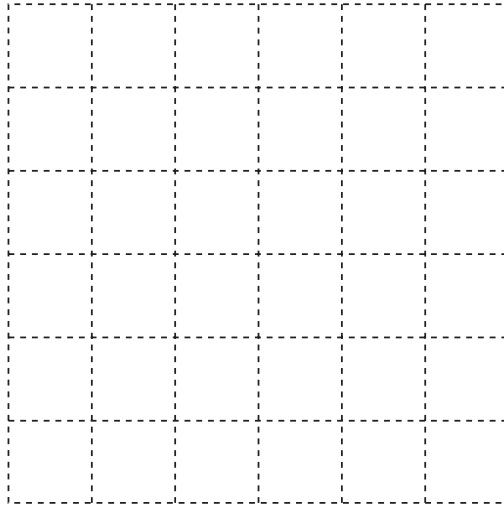
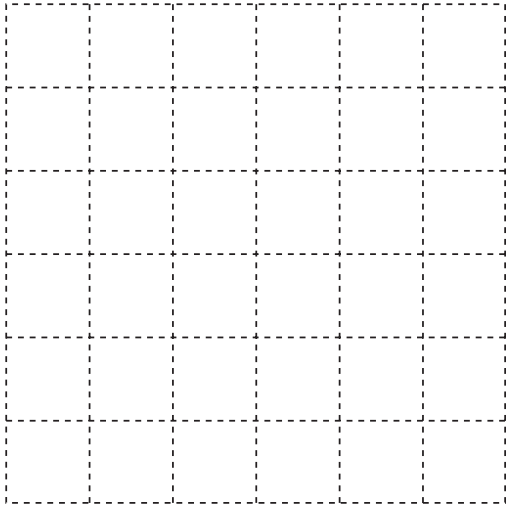

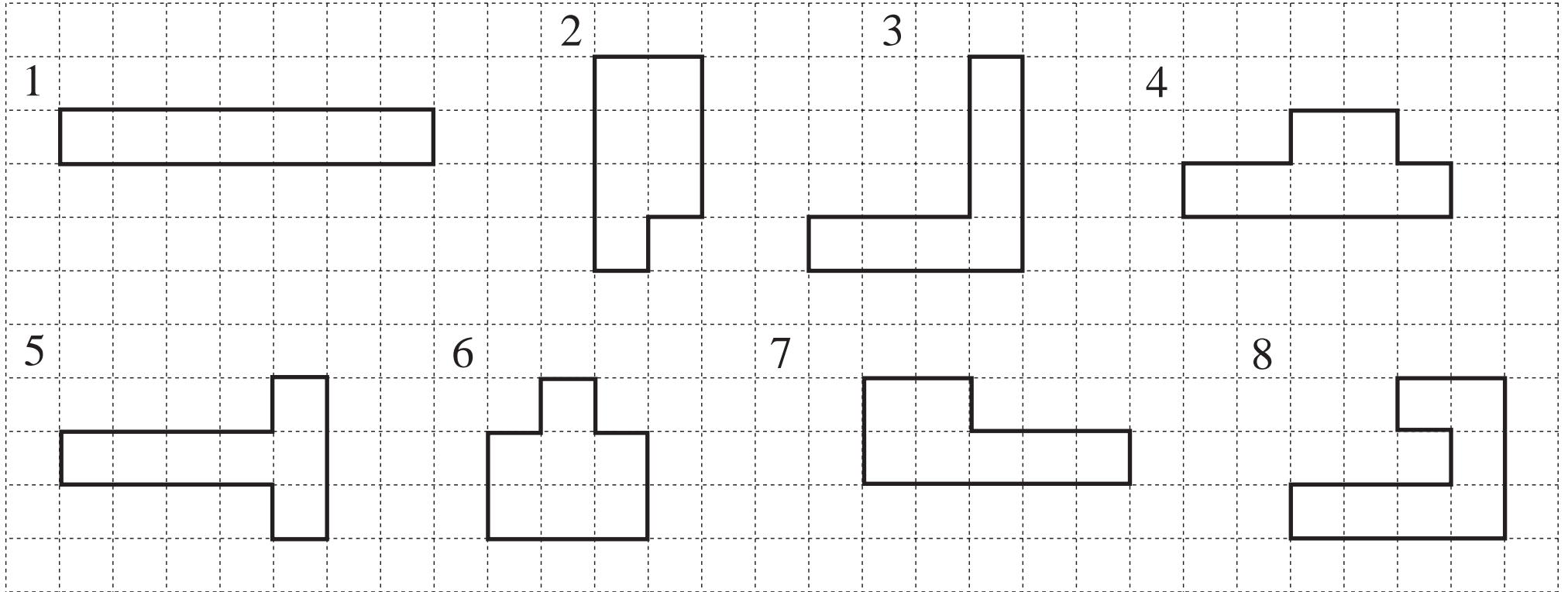



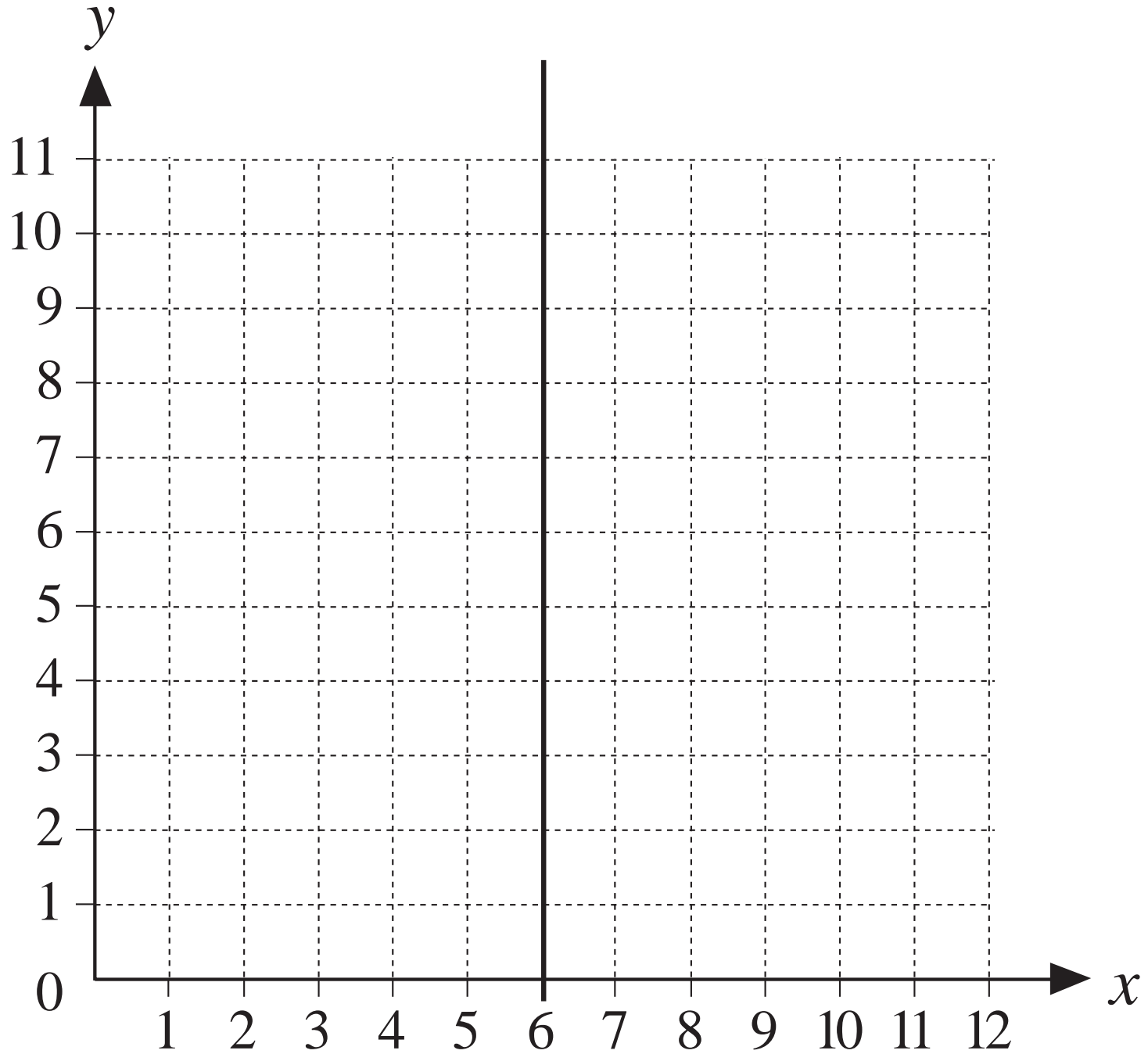



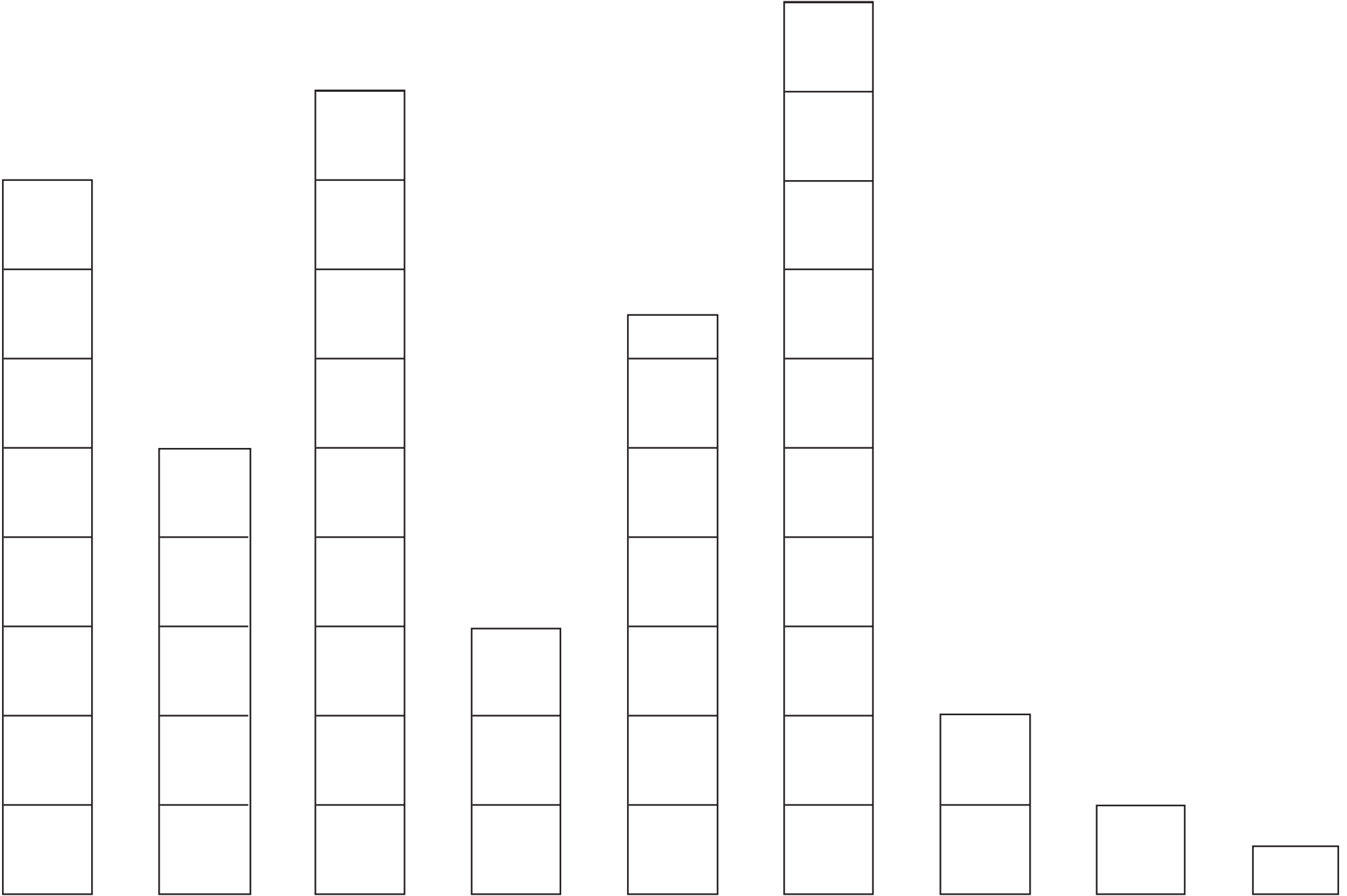



Population

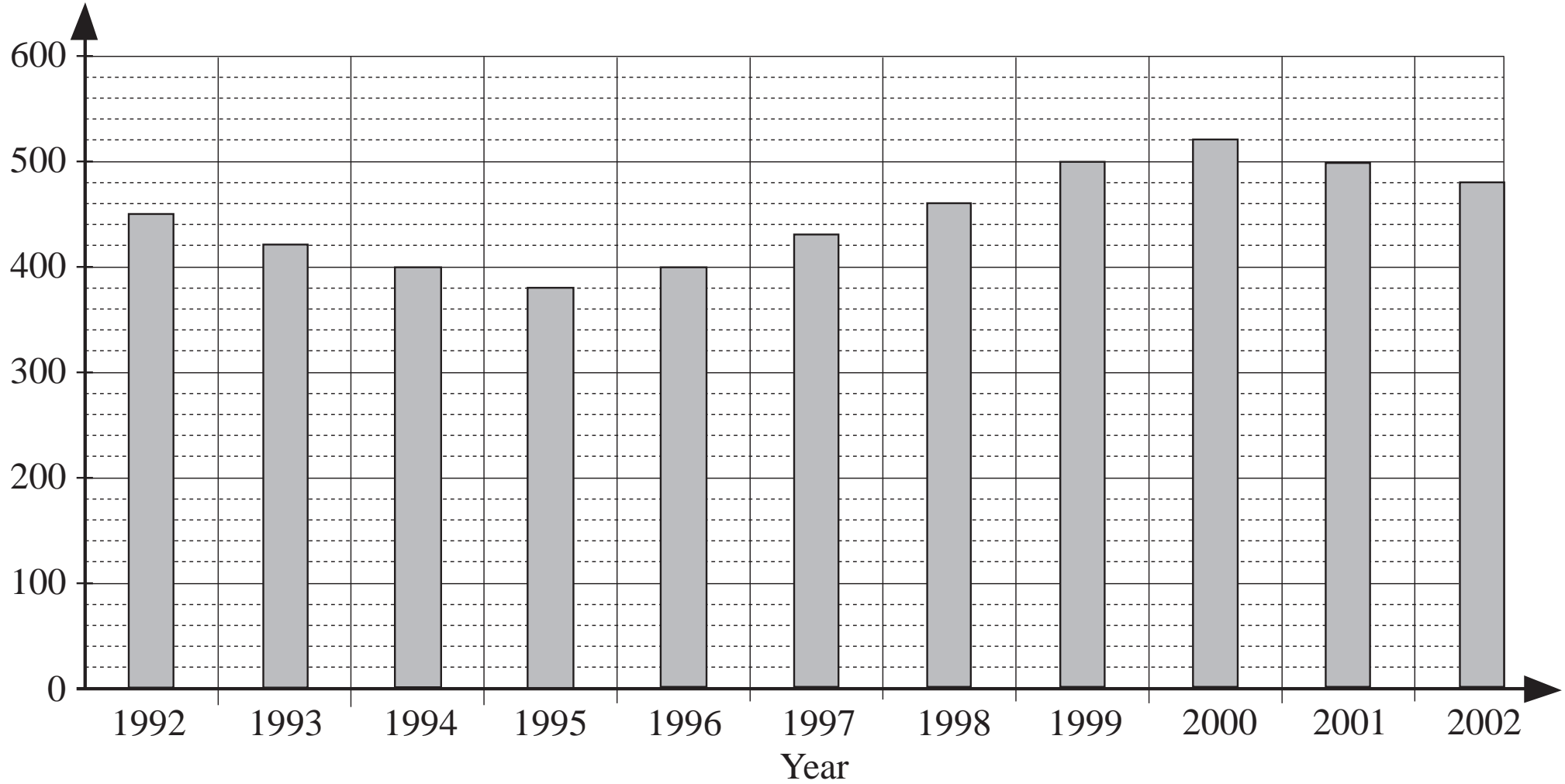

Year	1992	1993									
Population											

Year	1st	2nd	3rd	4th	5th	6th
No. of pupils	42	40	46	42	38	41

LP 146/6a

Jan	Feb	Mar	Apr	May	Jun	Jul	Aug	Sep	Oct	Nov	Dec

LP 148/6a

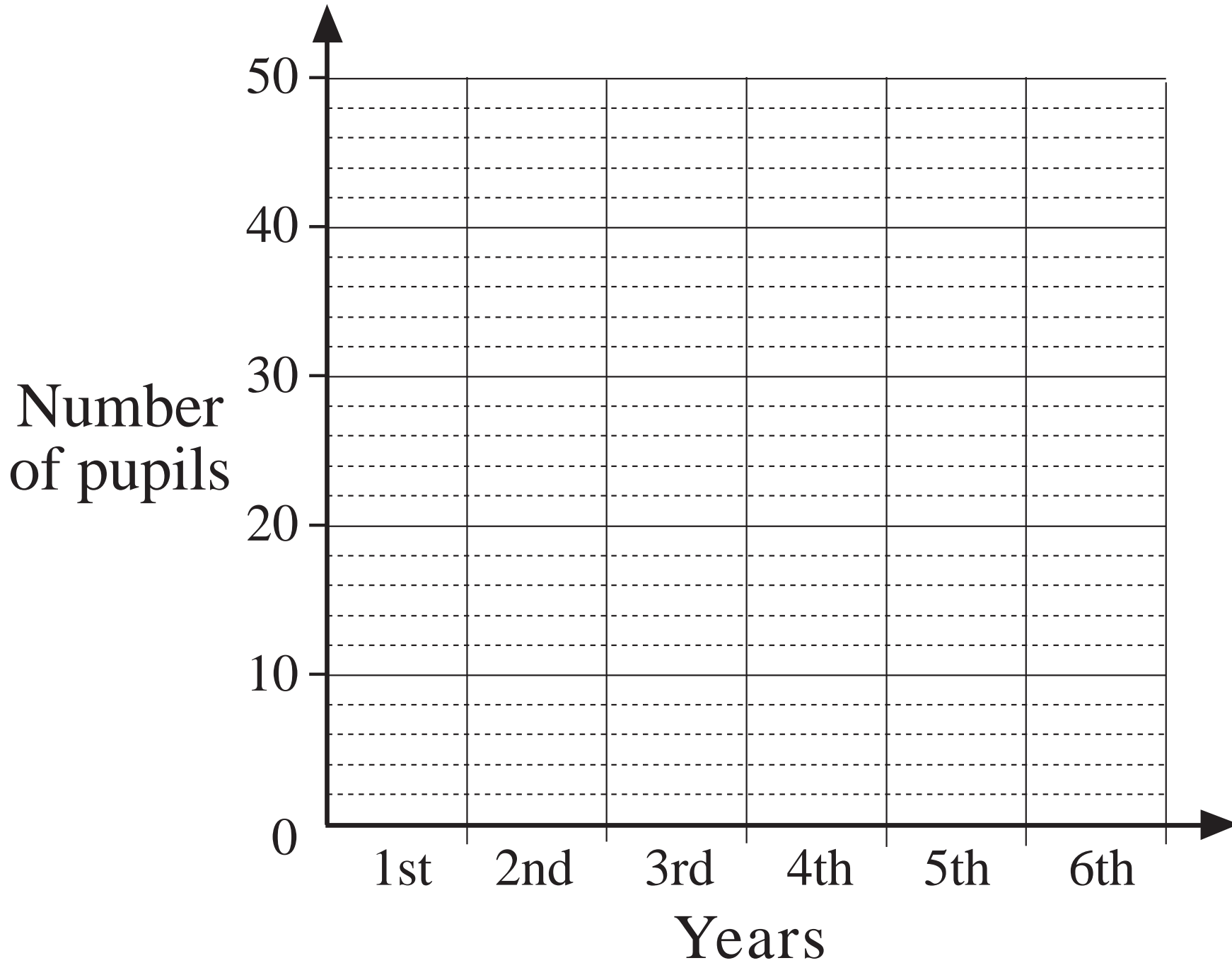

Children					
Balance (£)					

Balance (£)

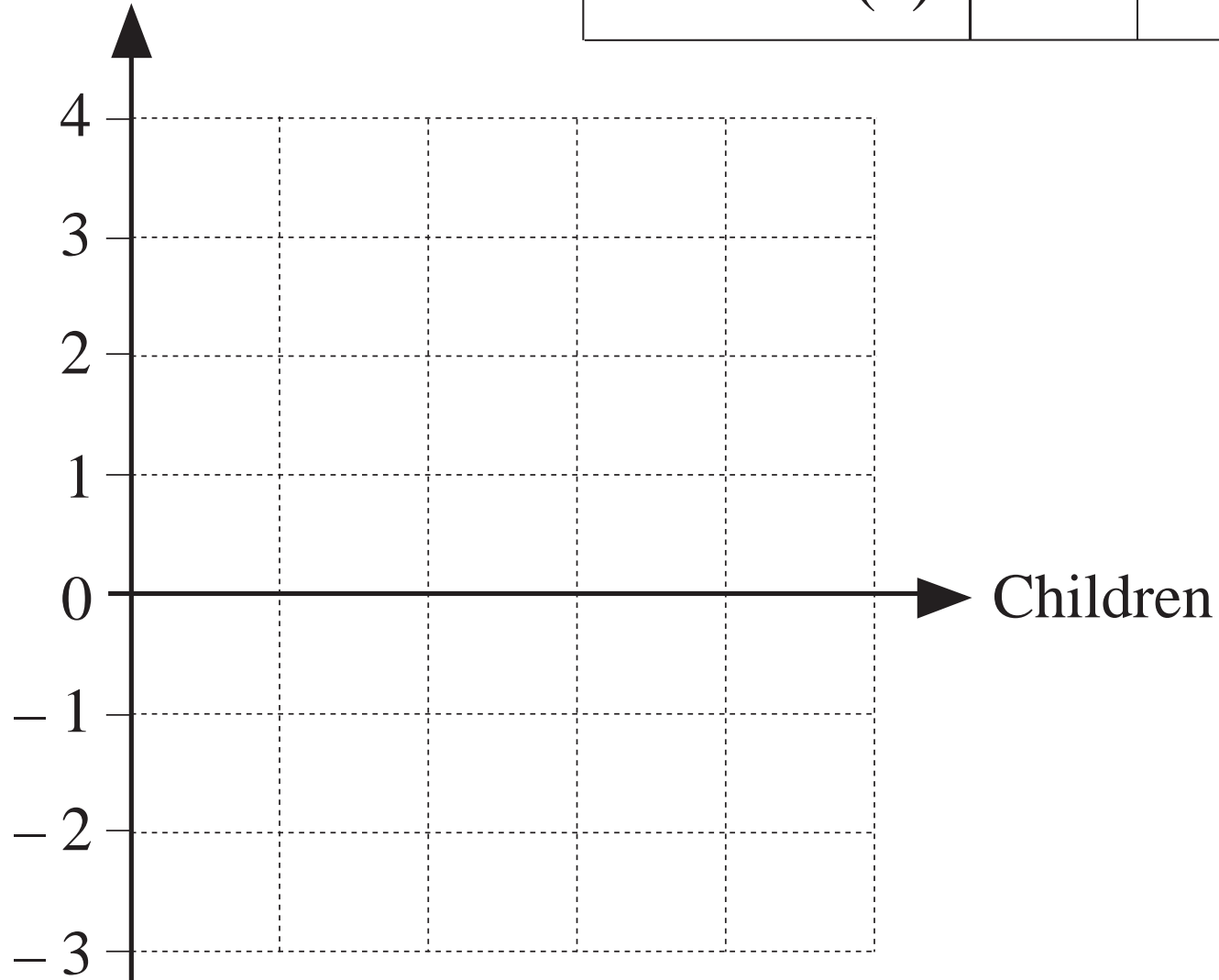

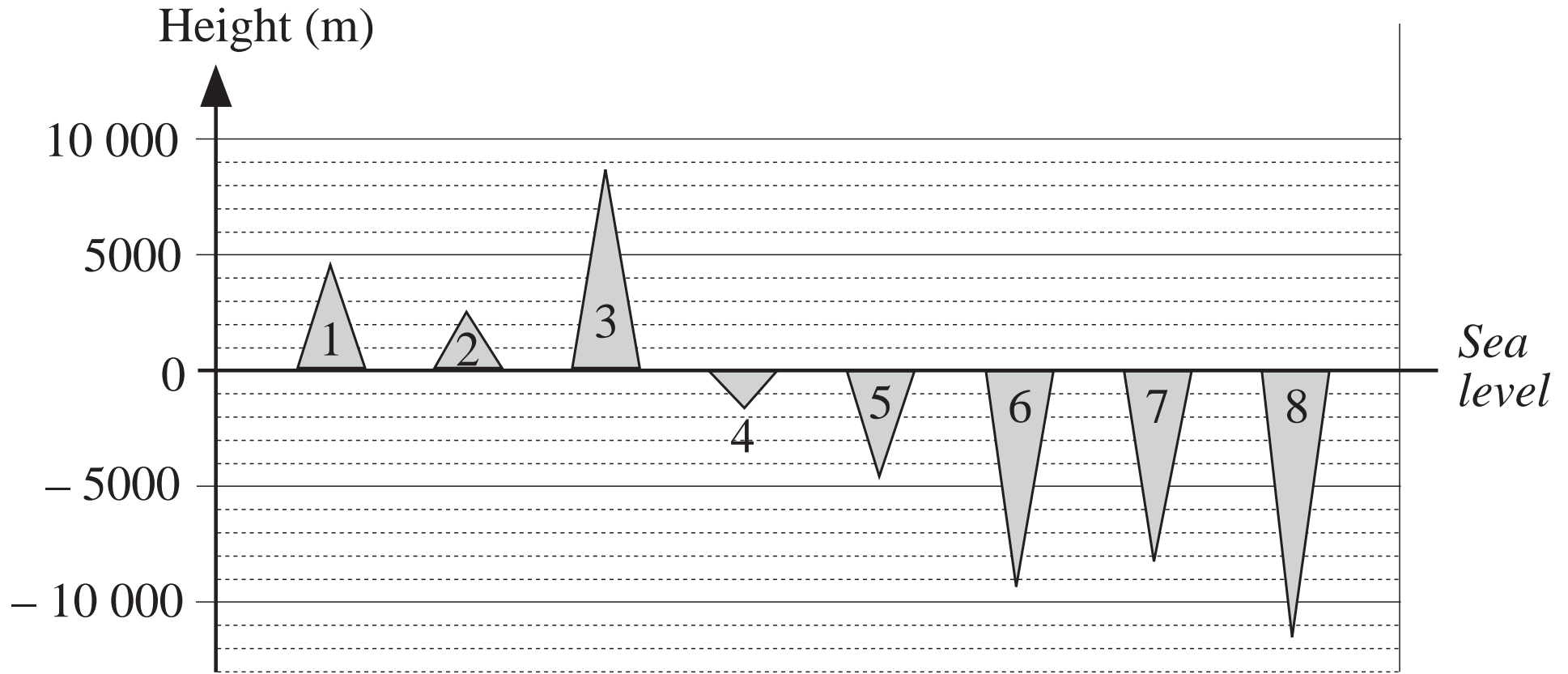

- |                 |   |                      |   |                      |   |                      |   |
|-----------------|---|----------------------|---|----------------------|---|----------------------|---|
| 1. Alps         | ≈ | <input type="text"/> | m | 5. Mediterranean Sea | ≈ | <input type="text"/> | m |
| 2. Carpathians  | ≈ | <input type="text"/> | m | 6. Atlantic Ocean    | ≈ | <input type="text"/> | m |
| 3. Himalayas    | ≈ | <input type="text"/> | m | 7. Indian Ocean      | ≈ | <input type="text"/> | m |
| 4. Adriatic Sea | ≈ | <input type="text"/> | m | 8. Pacific Ocean     | ≈ | <input type="text"/> | m |

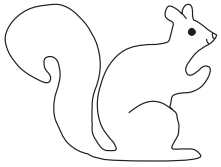

 = 150 acorns

Monday:



$5 \times 150 =$

Tuesday:

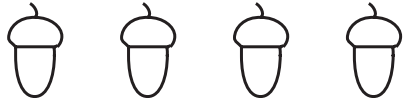

-----

Wednesday:

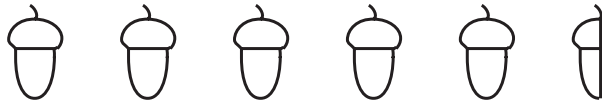

-----

Thursday:



-----

Friday:



-----

Saturday:



-----

Sunday:

-----

a)



Number in each group	27	9	3	1
Number of groups				

b)

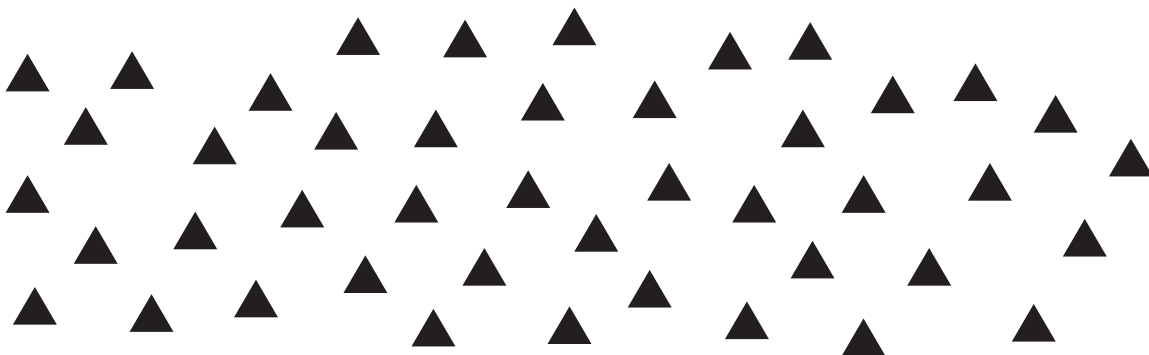

Number in each group	16	4	1
Number of groups			



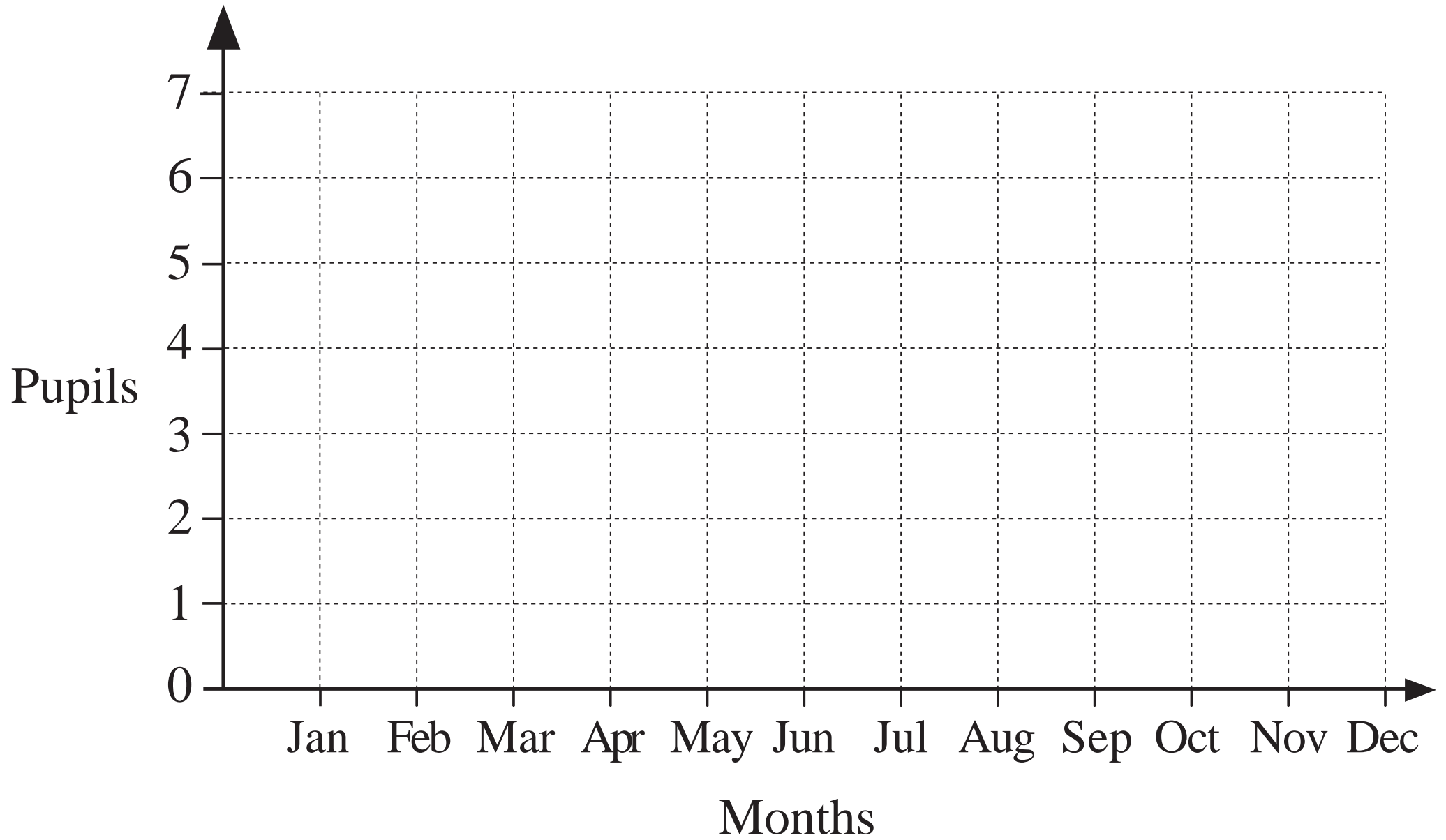

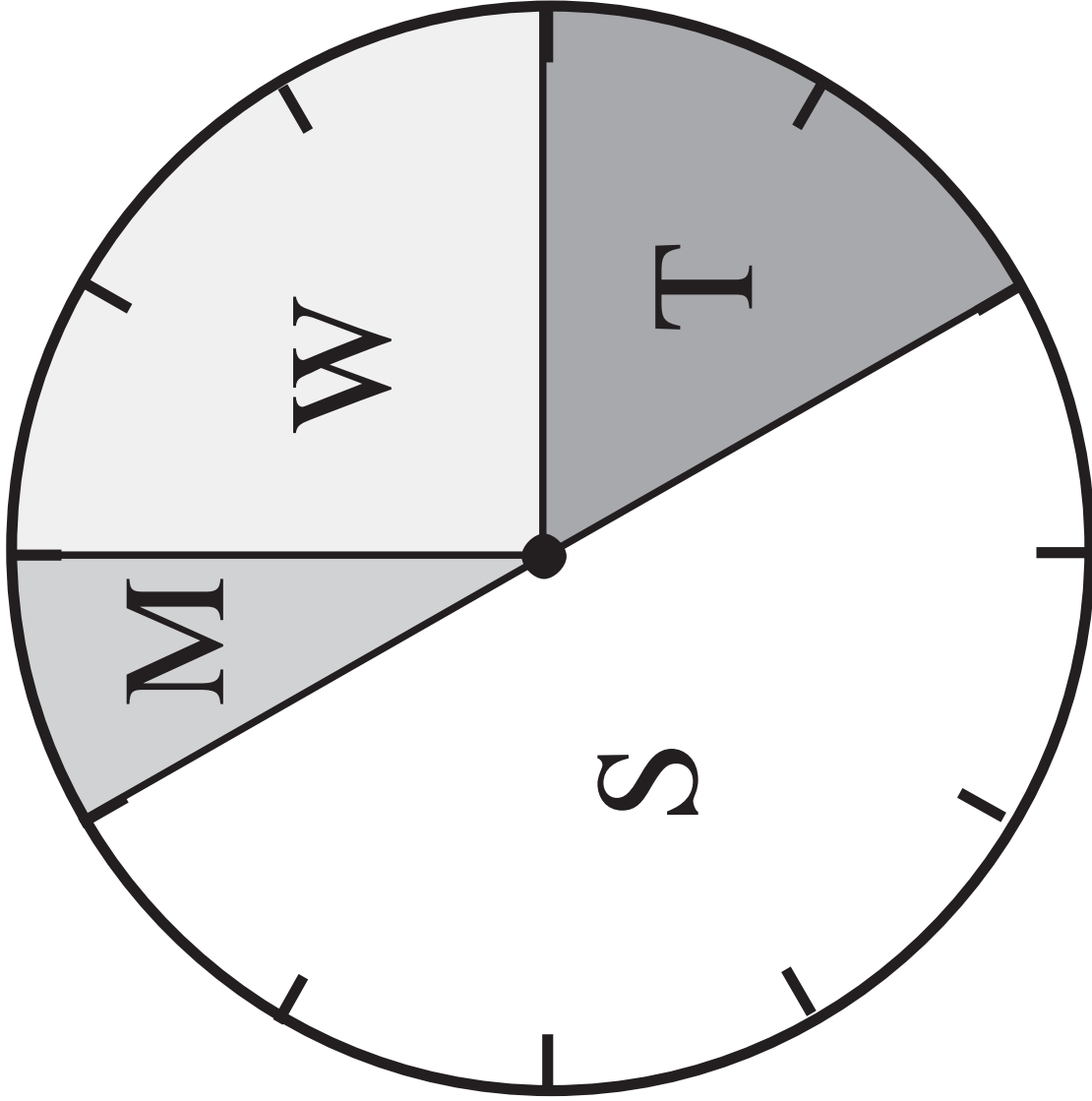



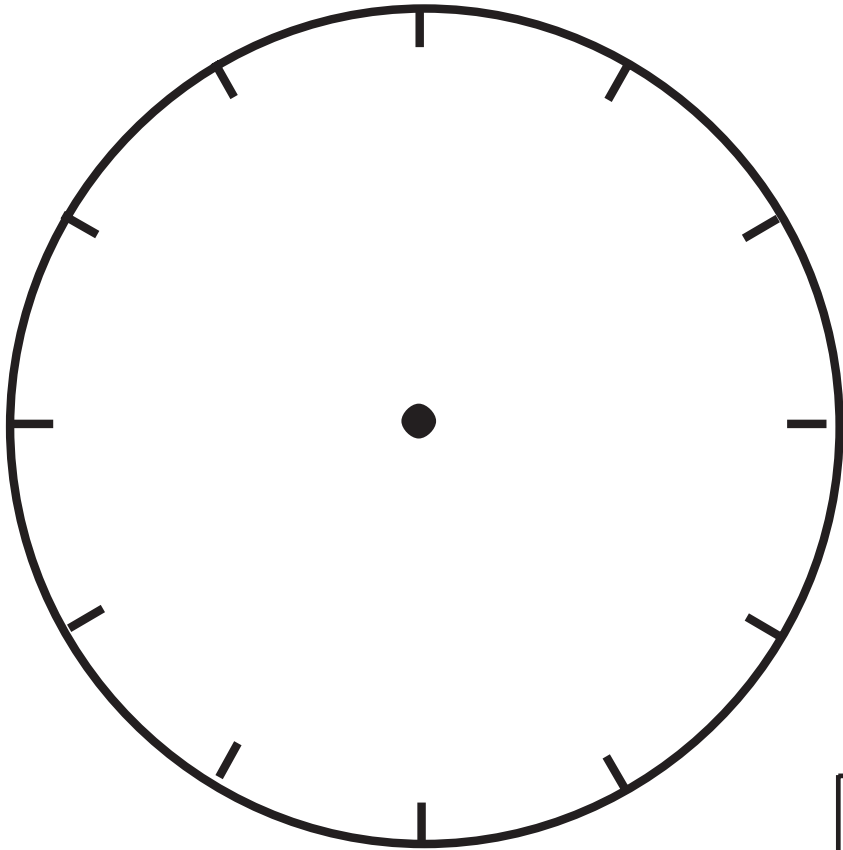

	M	S	T	W
No. of pupils				
Fraction				

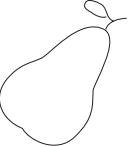

					
No. of pupils					
Fraction					

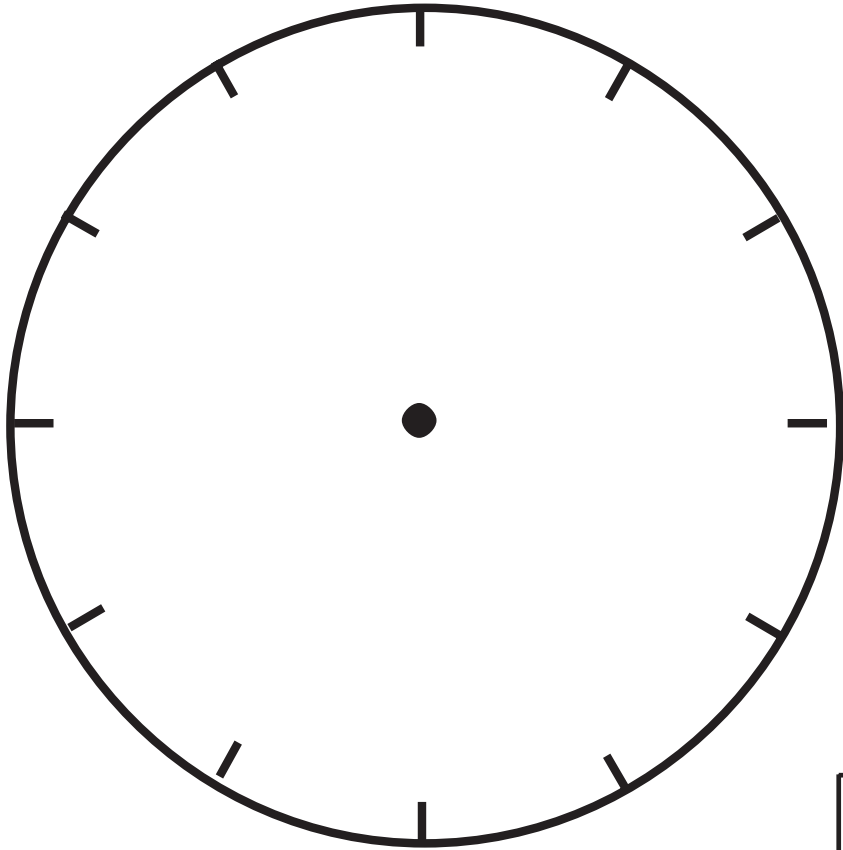

No. of pupils					
Fraction					

Colour of bag	<i>Green</i>	<i>Blue</i>	<i>Red</i>	<i>Yellow</i>	<b>Total</b>
No. of pupils					
Fraction					

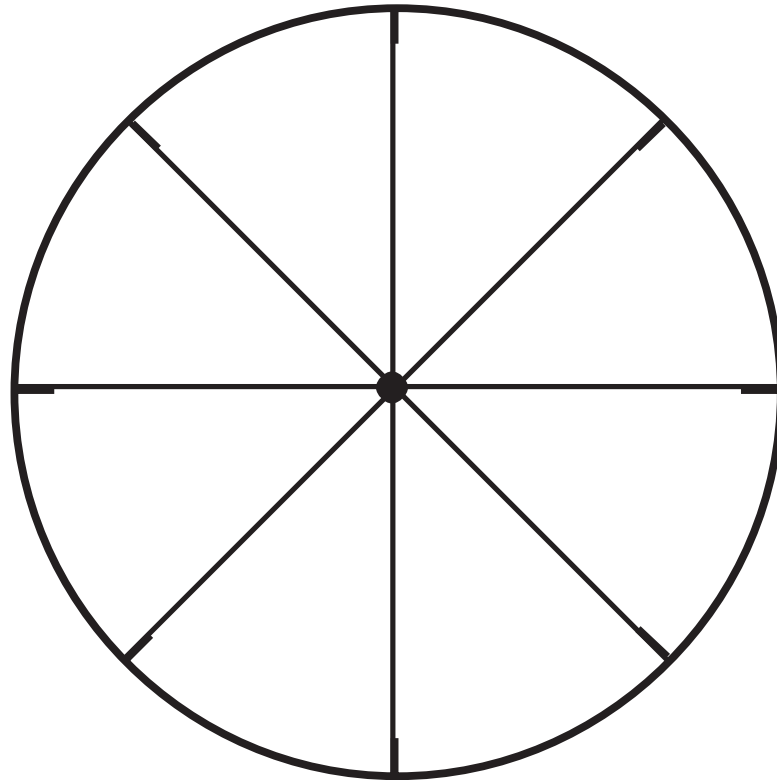

January: 

July: 

February: 

August:

March: 

September:

April: 

October:

May: 

November:

June: 

December:

67 scientists

French

47

German

35

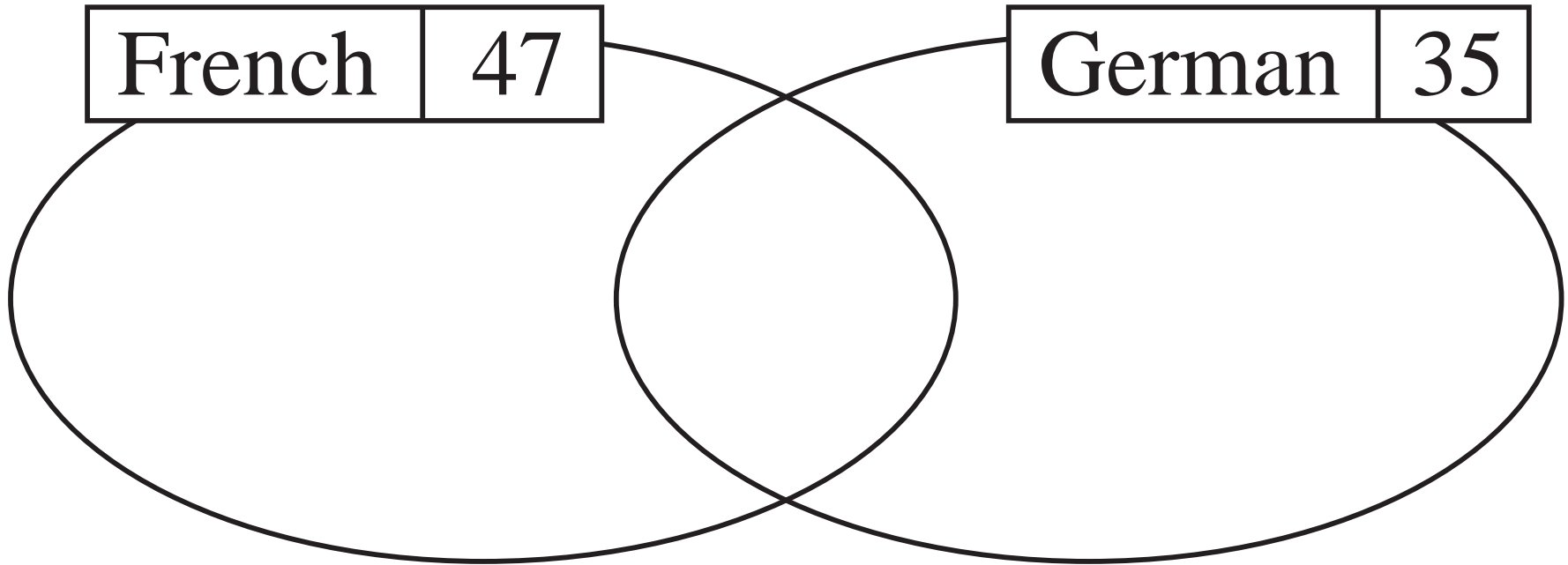



Number	1	2	3	4	5	6	7	8	9	10	11
Height (m)	6	14	5.4	13.6	6.5	15	5	14.5	5.8	14	5.2

LP 150/4

<i>a</i>	1	1	1										
<i>b</i>	1	2	3										
<i>c</i>	60												





### Distance run (m)

*Mon:* 2800 m

*Tue:* 4300 m

*Wed:* 3500 m

*Thu:* 2.9 km

*Fri:* 3200 m

*Sat:* 10 km

*Sun:* 6800 m

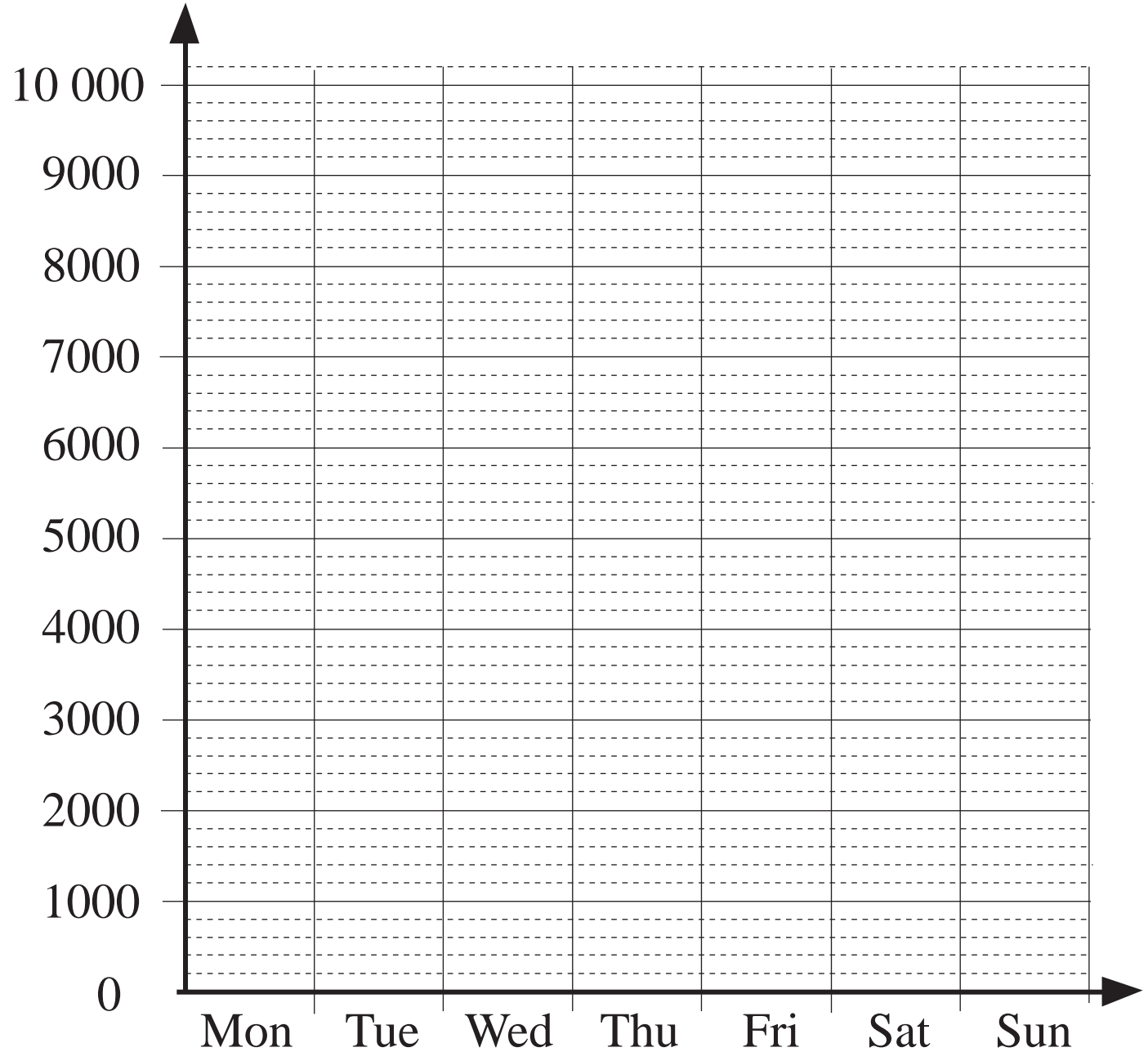

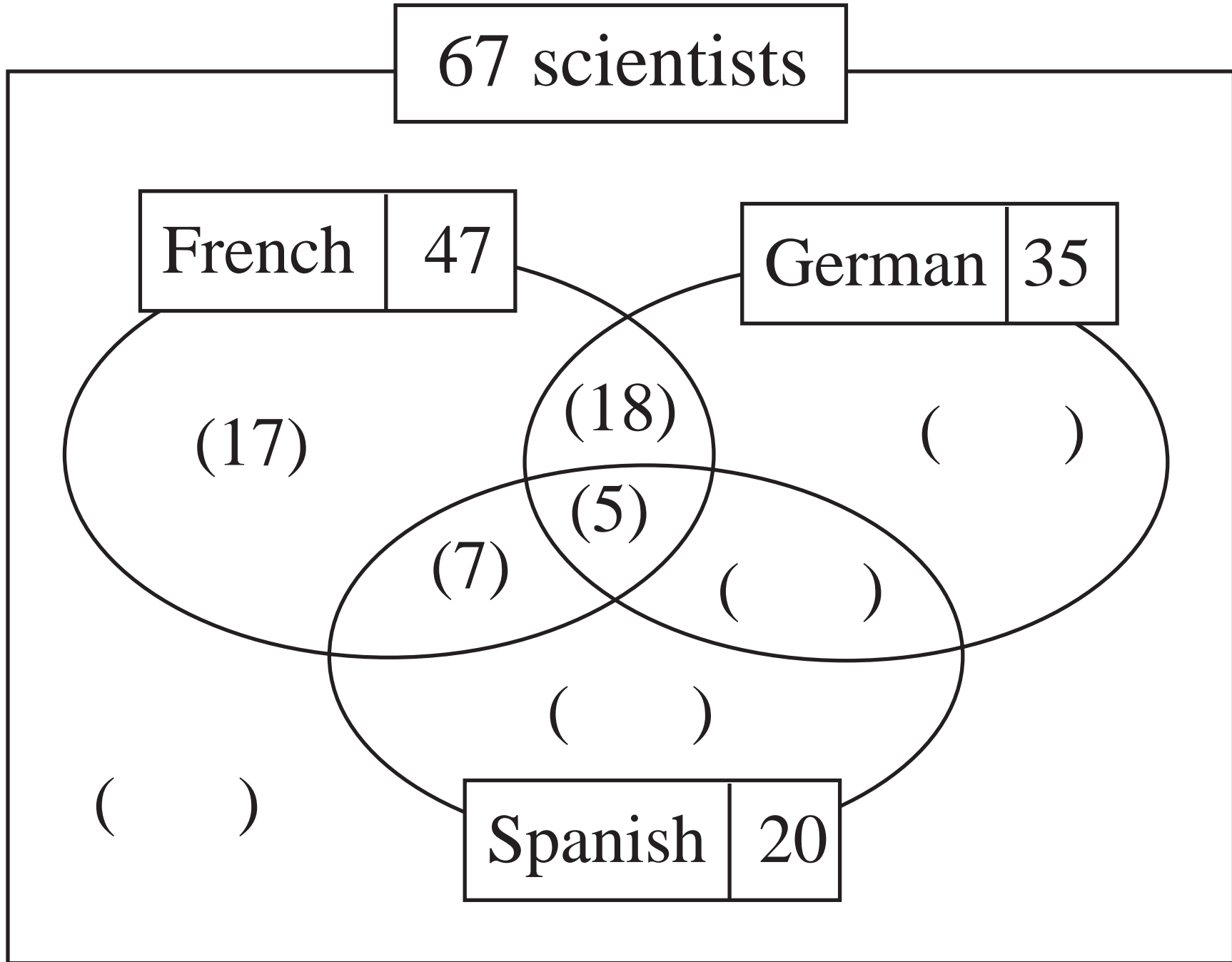



Number of people

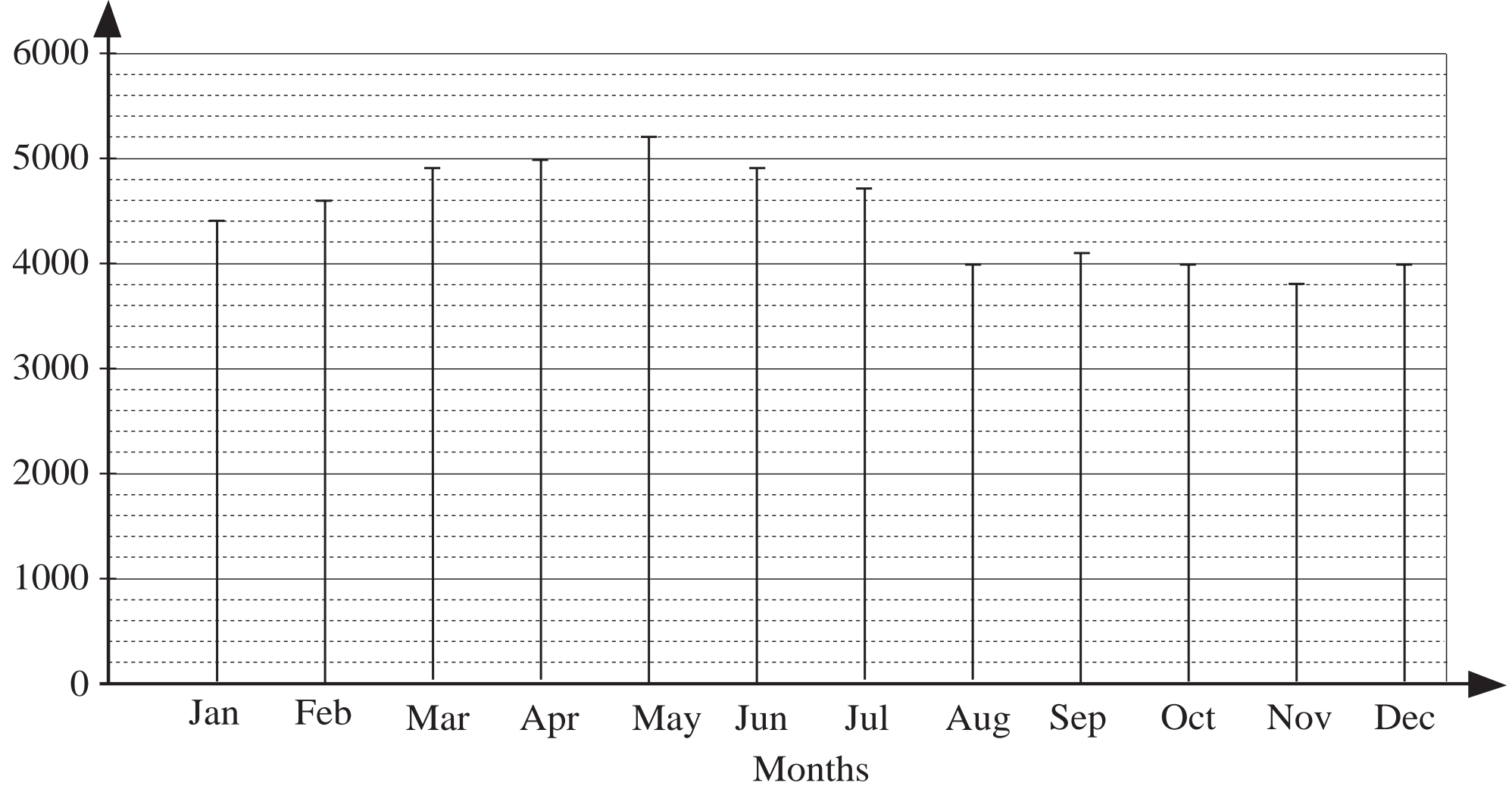

Month	Jan	Feb	Mar	Apr	May	Jun	Jul	Aug	Sep	Oct	Nov	Dec
No. of people												

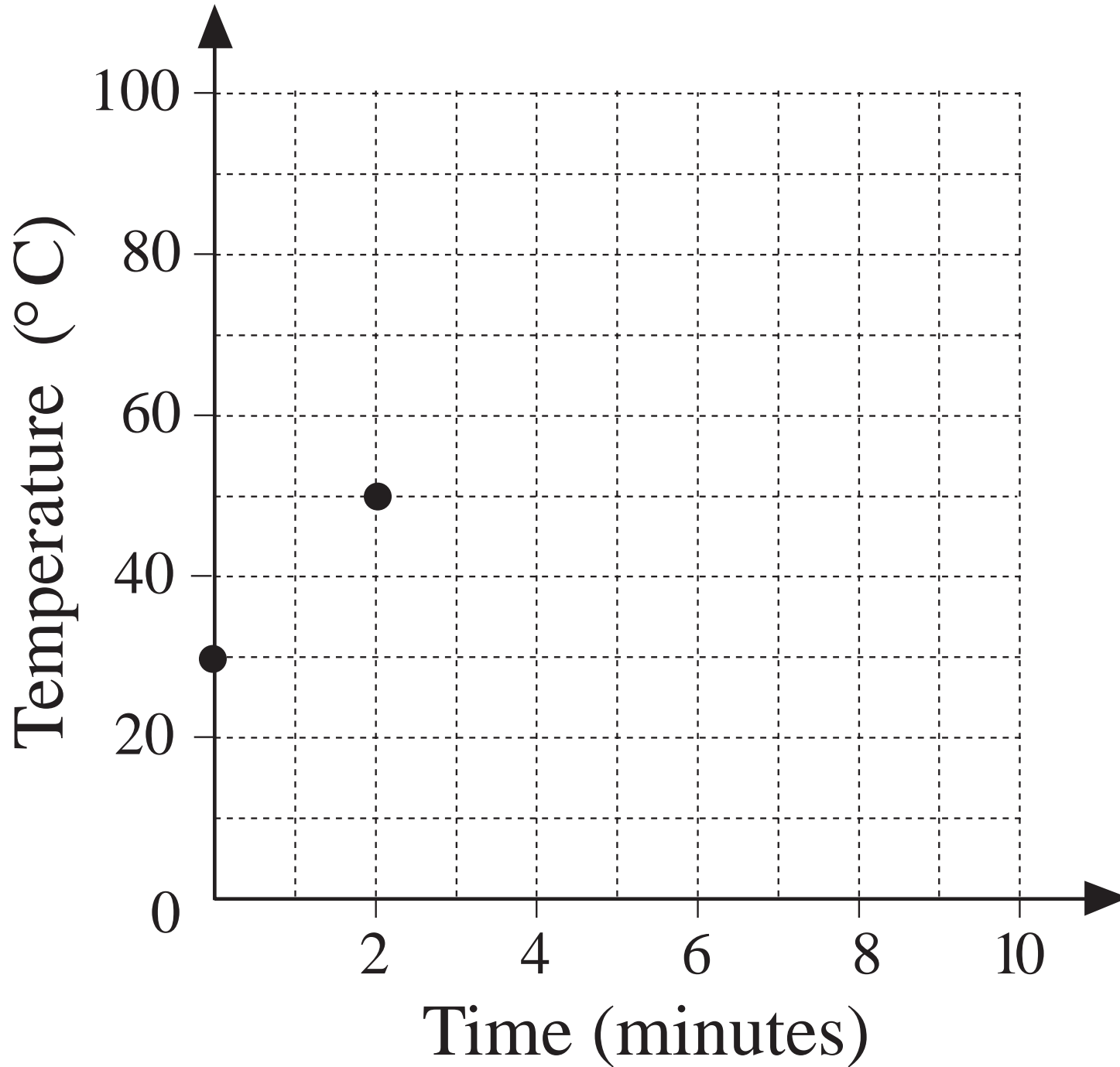

Time (minutes)	0	1	2	3	4	5	6	7	8	9	10
Temperature ( $^{\circ}\text{C}$ )	30		50		70						

LP 152/5a

$x$	12	4	3
$y$	4	12	13

(a)  $x + y = 16$

(b)  $x \times y = 48$

(c)  $y = x - 8$

$x$	12	4	3
$y$	4	12	16

(d)  $y = x + 4$

(e)  $x + 2 = y - 2$

(f)  $y + 8 = x$

$x$	12	4	16
$y$	16	8	20

(g)  $y = 16 - x$

(h)  $x \div 4 = y$

(i)  $48 \div x = y$

LP 152/6

- a) 54 thousand 3 hundred and 21
- b) thirty thousand, six hundred and eleven
- c) 99 thousand, 7 hundred and 48
- d) forty-two thousand, nine hundred and eight
- e) twenty-six thousand and seventy three

TTh	Th	H	T	U

Time (minutes)	0	1	2	3	4	5	6	7	8	9
Height (cm)	0	12	24	36	48					

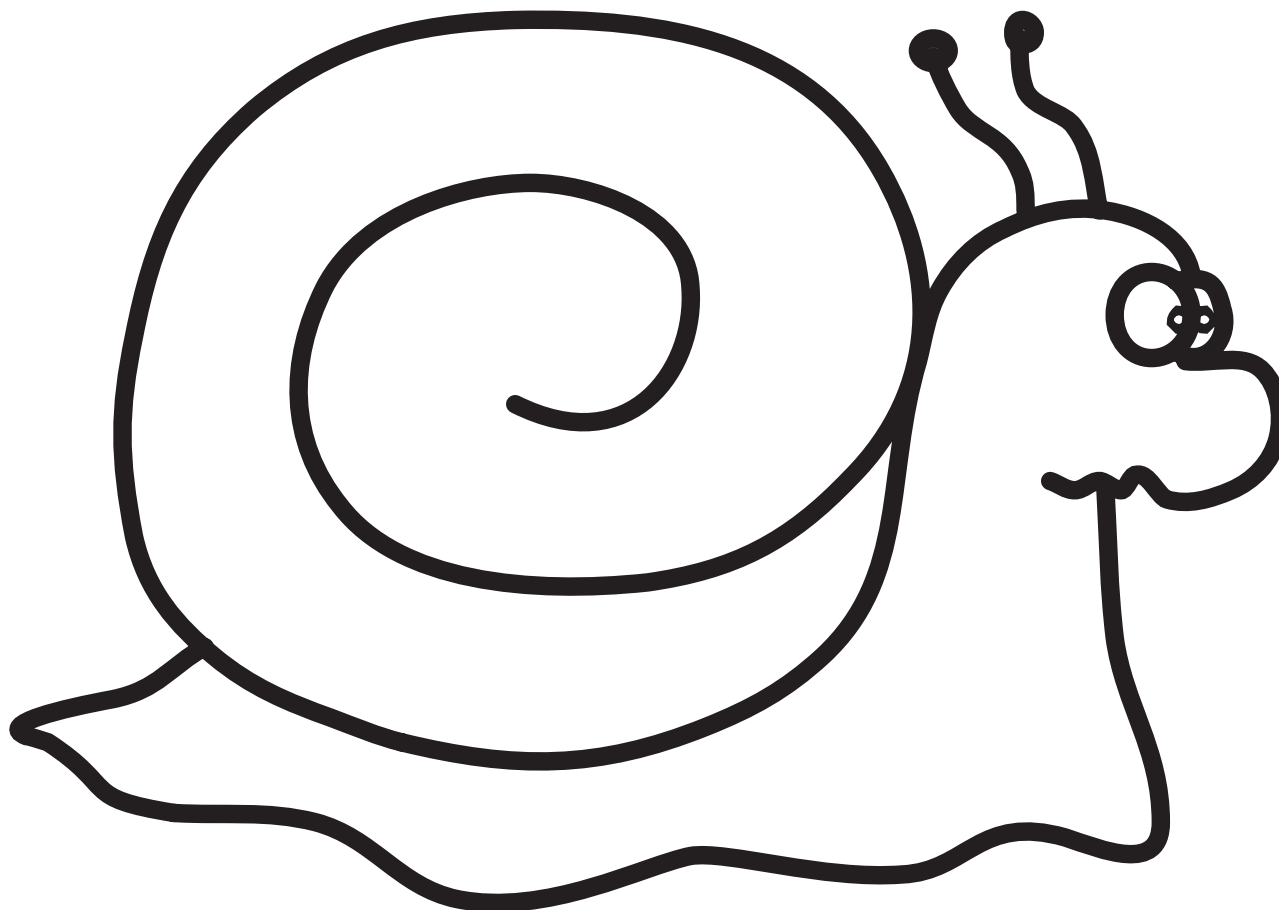

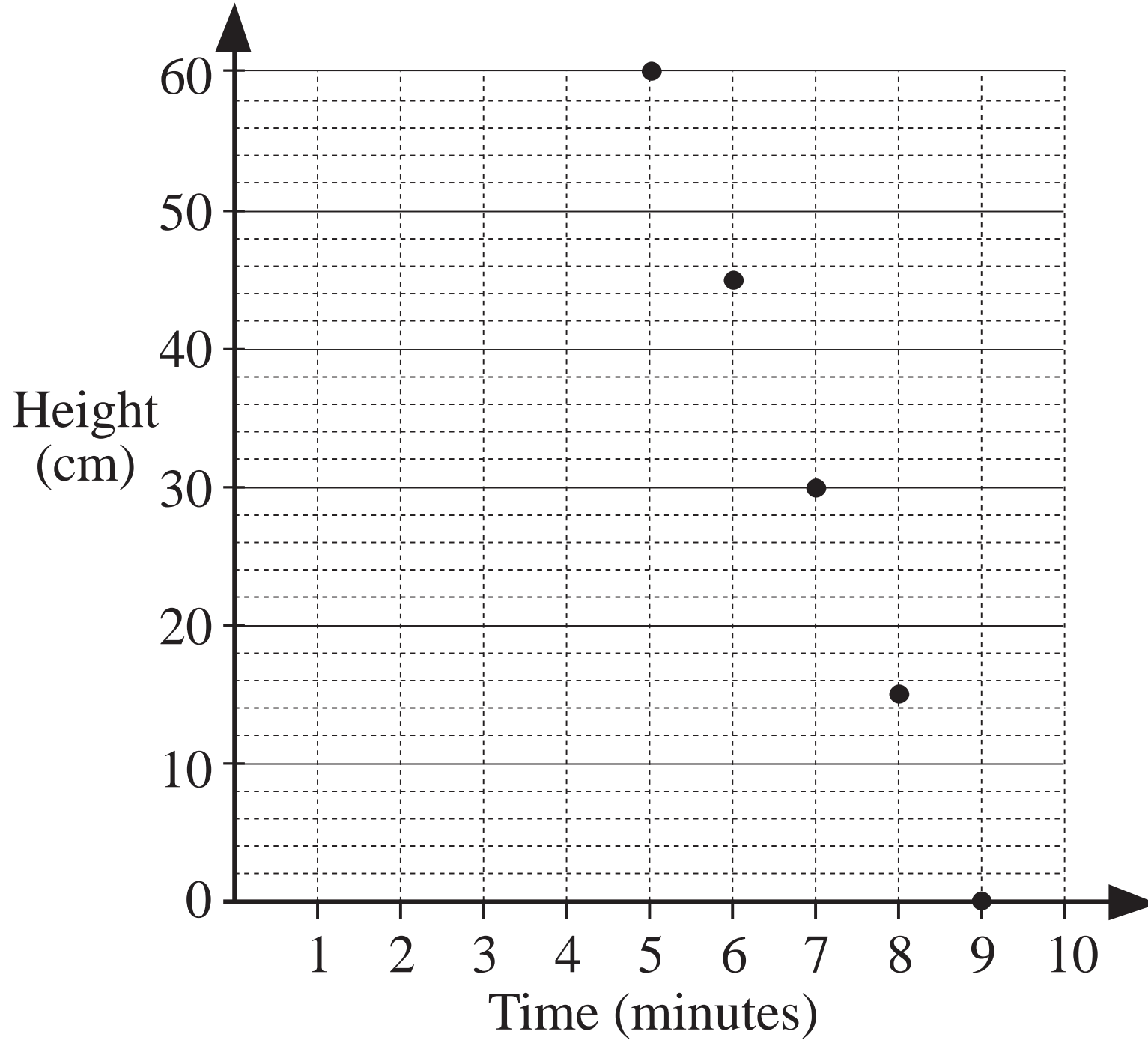



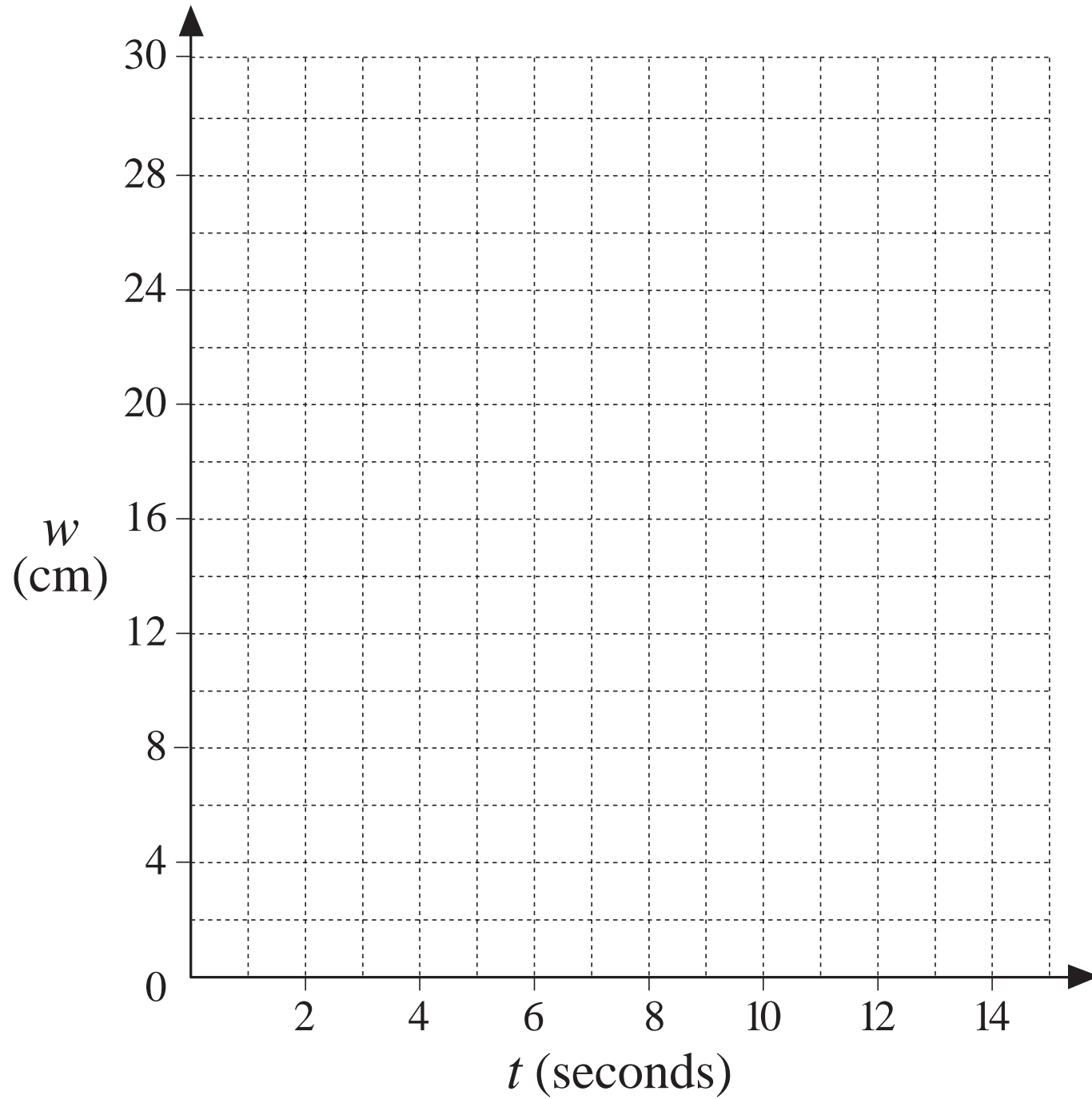



$t$	0	1	2	3	4	5	6	7	8	9	10
$w$											

LP 153/7a

$t$	0	1	2	3	4	5	6	7	8	9	10
$w$	5										

LP 153/7c

Rounded to nearest:

Number	10	100	1000	10 000
21 875				
85 000				
36 243				
54 999				

a)

$a$	20	200	2000	1260	1400			
$b$	50					100	2500	9000

Rule: .....

b)

$x$	20	200	2000	1260	1400			
$y$	50					100	2500	9000

Rule: .....

c)

$u$	20	200	2000	1260	1400			
$v$	50					100	2500	9000

Rule: .....

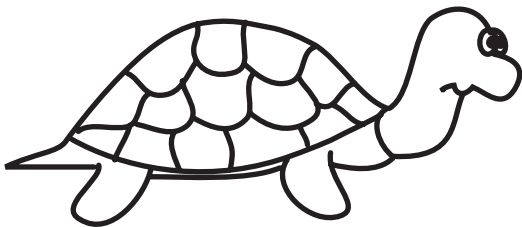
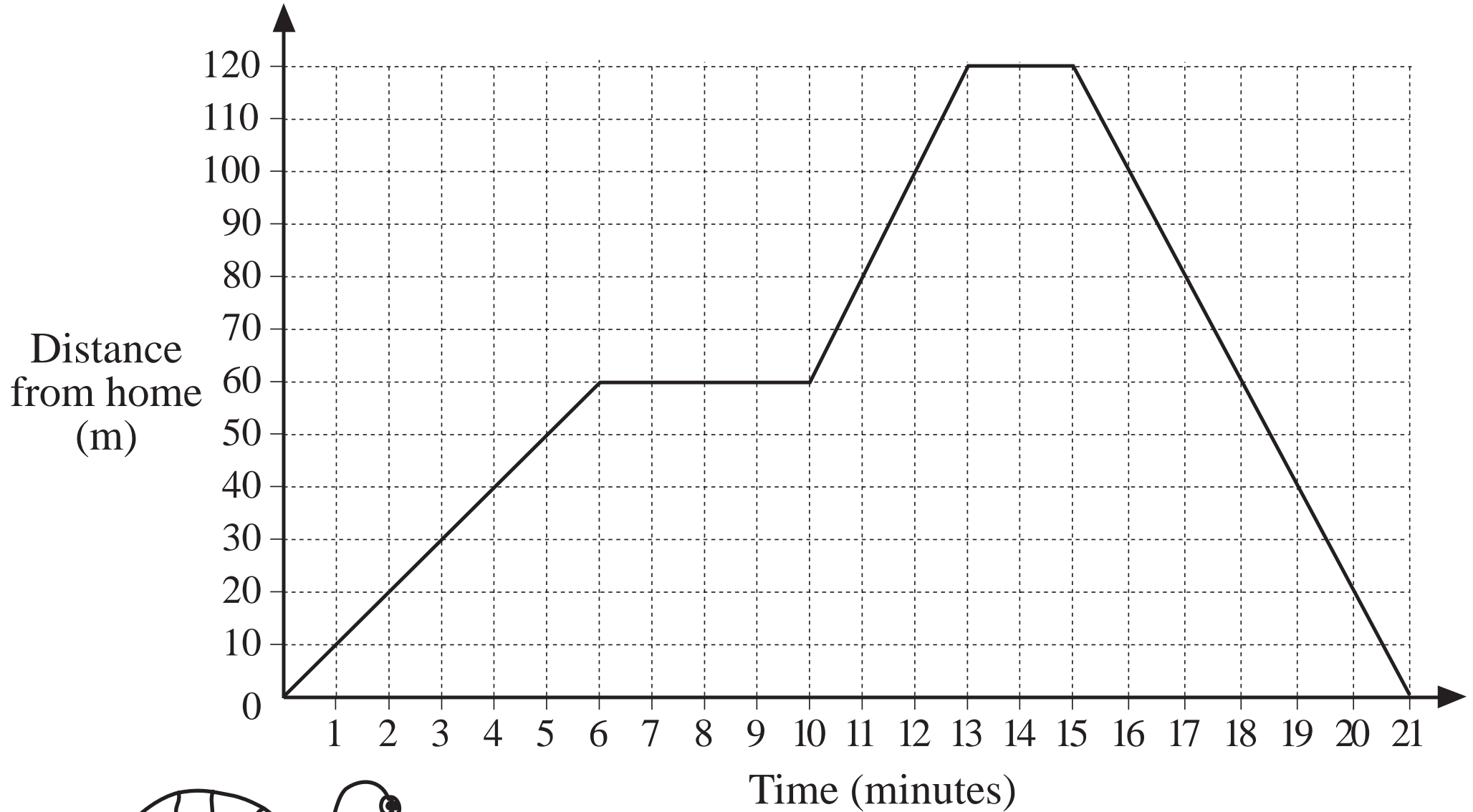

①

$x$	10	5	2
$y$	5	10	13

- Ⓐ  $x + y = 15$   
Ⓑ  $x \times y = 50$   
Ⓒ  $y = x - 5$

②

$x$	10	5	2
$y$	5	10	25

- Ⓓ  $y = x + 5$   
Ⓔ  $x + 15 = y - 10$   
Ⓕ  $y - 5 = x$

③

$x$	10	5	2
$y$	15	10	7

- Ⓖ  $y = 15 - x$   
Ⓖ  $x \div 2 = y$   
Ⓖ  $50 \div x = y$

Harvey's age (years)	0	1	2	4	7	15	18	27			28
Dad's age (years)	28								35	46	

LP 155/2

Time (minutes)	0	1	2	3	4	5	6	7	8	9
Outflow (litres)	0									
Water left (litres)	320									

LP 155/3

a)

	2	7	3	6	4
+	7	2	6	3	5
<hr/>					

b)

		4	3	5	1	8
		1	2	4	7	6
+		4	4	0	0	6
<hr/>						

c)

	7	3	4	1	9
-	6	3	4	2	0
<hr/>					

d)

		8	3	4	7
				×	6
<hr/>					

e)

			8	3	4	7
				×	1	2
<hr/>						
<hr/>						

f)

8	7	9	9	9	9



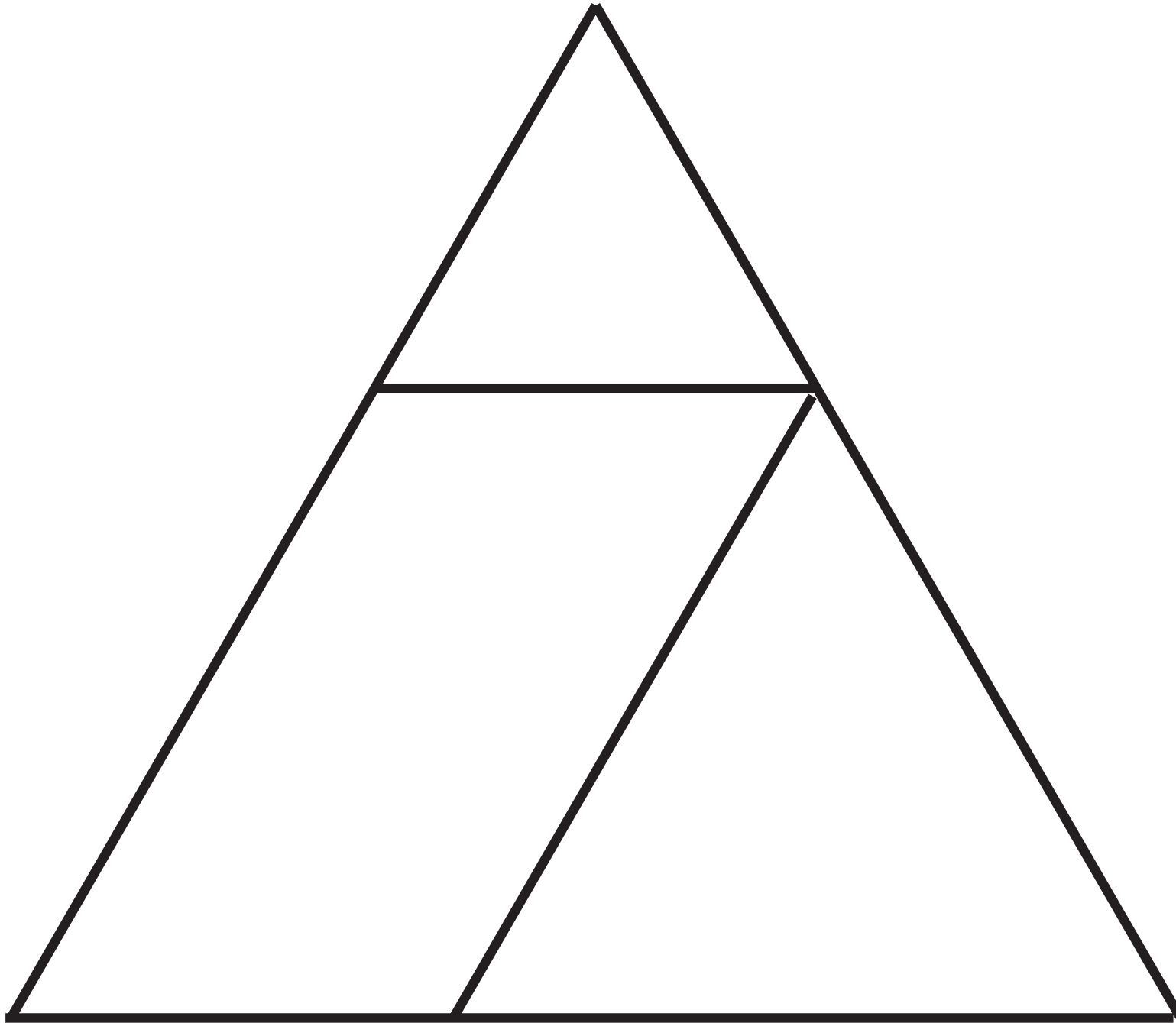

1	2	3
---	---	---

--	--	--

--	--	--

--	--	--

--	--	--

--	--	--

--	--	--

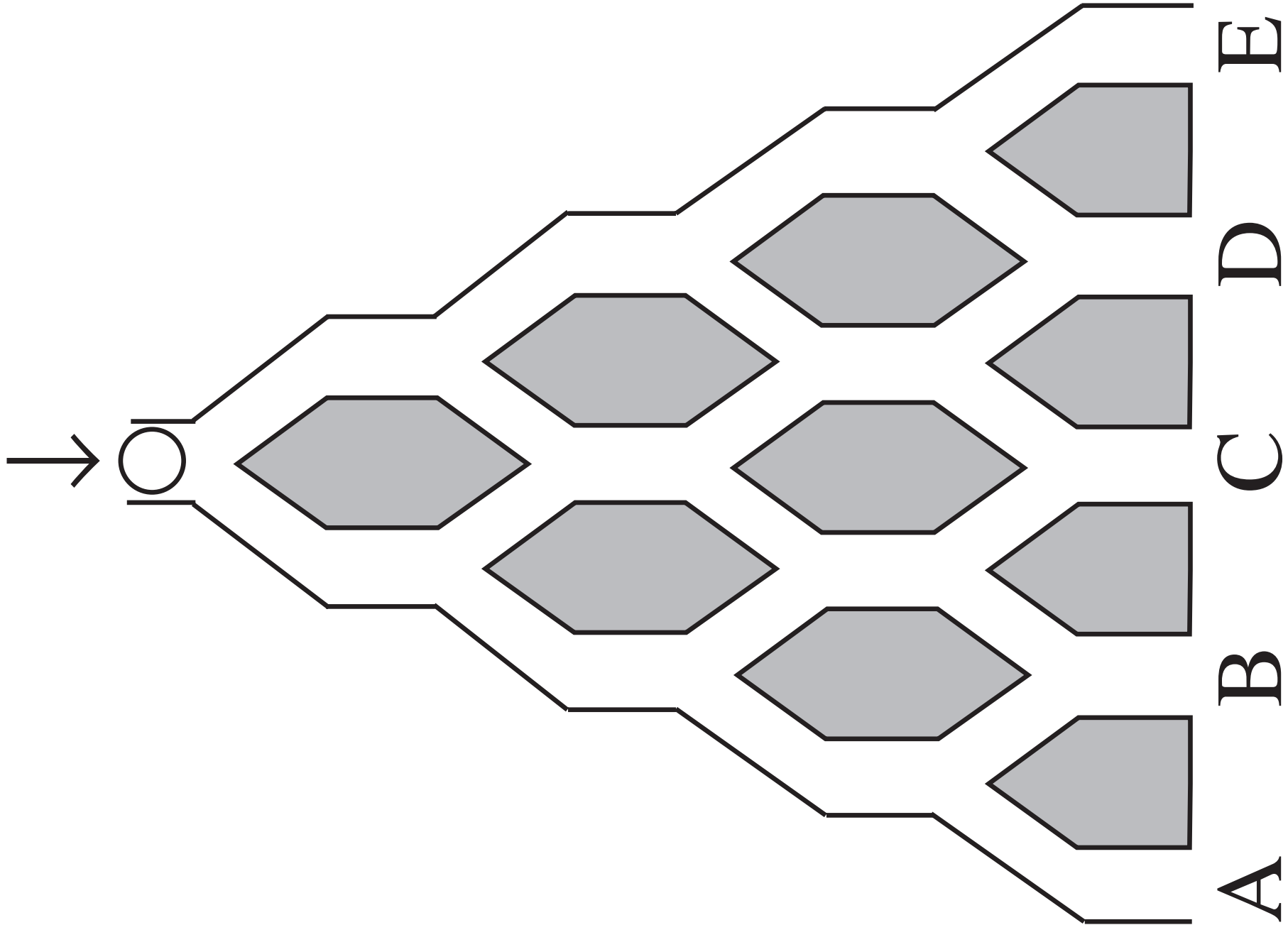



Outcome	Prediction	Experiment															Totals	
		1	2	3	4	5	6	7	8	9	10	11	12	13	14	15		
Both the same																		
Both different																		
1 red + 1 white																		
2 green																		

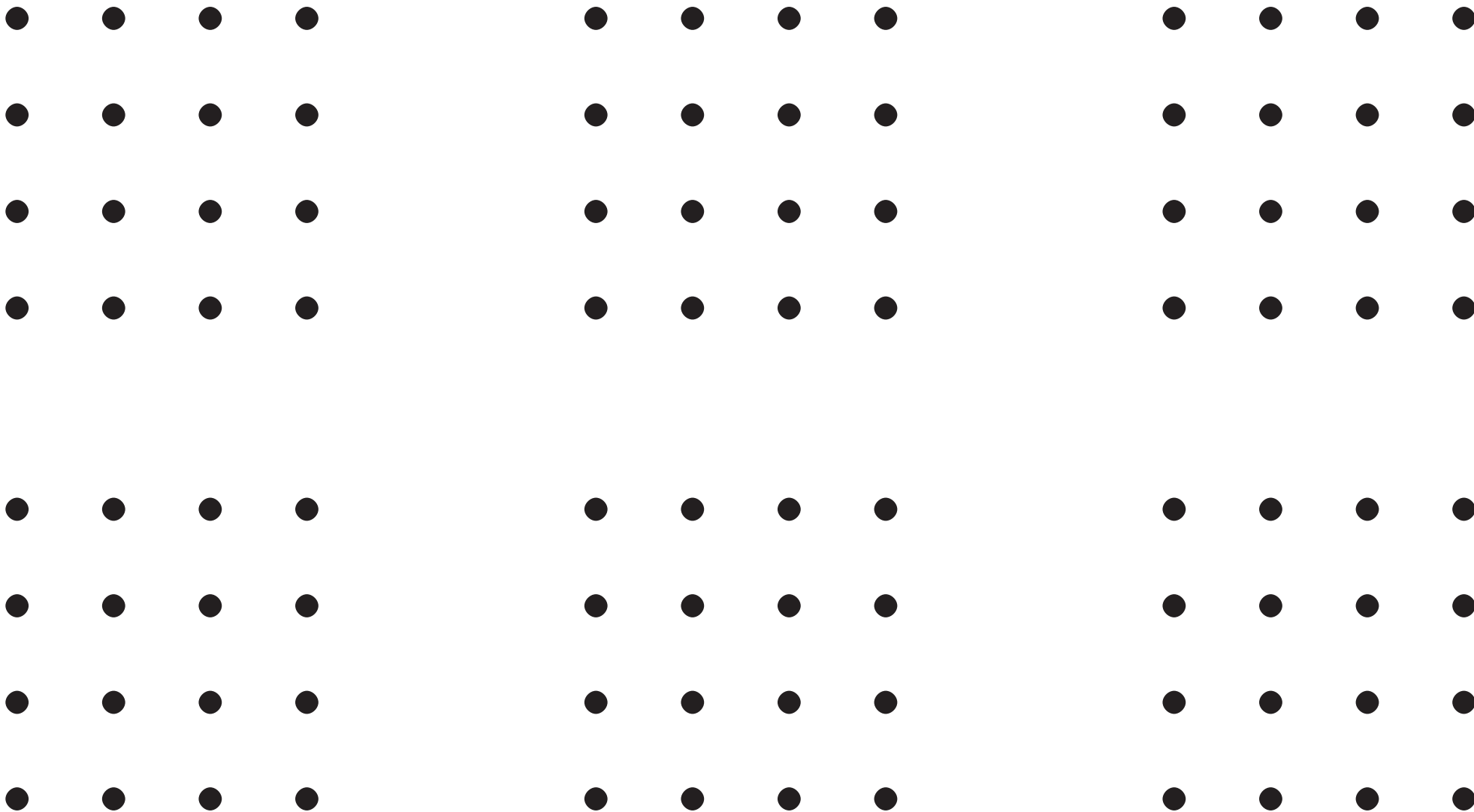







Outcome	Prediction	Tosses																				Totals
		1	2	3	4	5	6	7	8	9	10	11	12	13	14	15	16	17	18	19	20	
2 Heads																						
1 Head + 1 Tail																						
1 Tail + 1 Head																						
2 Tails																						

**Prediction****Tally of 20 throws****Totals**





5					
4					
3					
2					
1					
	A	B	C	D	E

1 and 1	
1 and 2	
1 and 3	
1 and 4	
1 and 5	
1 and 6	

2 and 2	
2 and 3	
2 and 4	
2 and 5	
2 and 6	

3 and 3	
3 and 4	
3 and 5	
3 and 6	
6 and 6	

4 and 4	
4 and 5	
4 and 6	
5 and 5	
5 and 6	

a)

1	2	3	4	5	6	8	9	10	12	15	16	18	20	24	25	30	36

c)

1	2	3	4	5	6	7	8	9	10	11	12	13

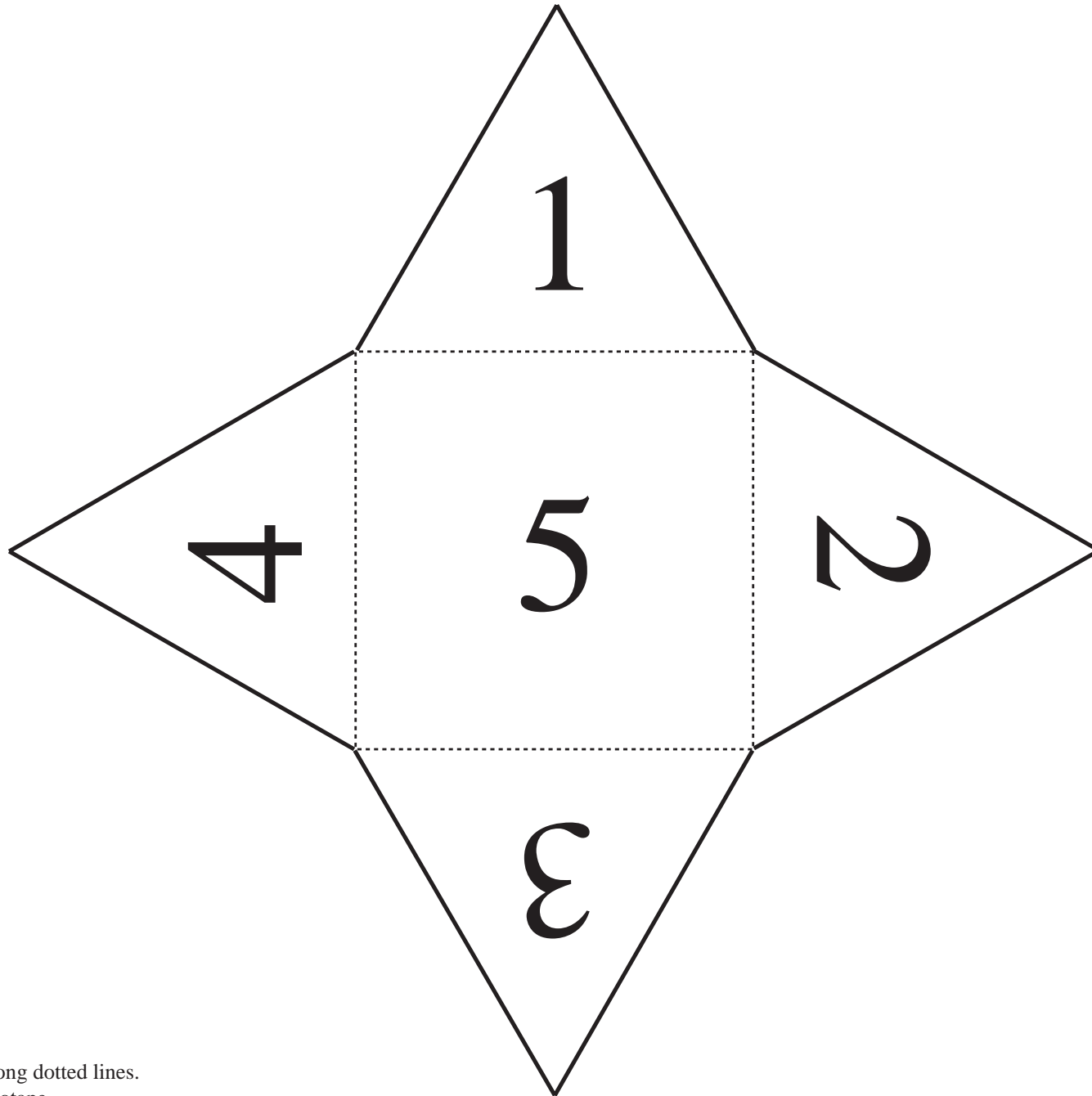

Cut along solid lines. Fold along dotted lines.  
Stick edges together with sellotape.

Outcome	1	2	3	4	5
Frequency	15	18	19	16	32
Probability					

## Possible outcomes

10 p coin										
20 p coin										
50 p coin										



Outcome	Prediction	Tosses																				Totals	
		1	2	3	4	5	6	7	8	9	10	11	12	13	14	15	16	17	18	19	20		
3 Heads																							
2 Heads + 1 Tail (in any order)																							
1 Head + 2 Tails (in any order)																							
3 Tails																							



--	--	--	--

--	--	--	--

--	--	--	--

--	--	--	--

--	--	--	--

--	--	--	--

--	--	--	--

--	--	--	--

--	--	--	--

--	--	--	--

--	--	--	--

--	--	--	--

--	--	--	--

--	--	--	--

--	--	--	--

--	--	--	--

--	--	--	--

--	--	--	--

--	--	--	--

--	--	--	--

--	--	--	--

--	--	--	--

--	--	--	--

--	--	--	--



6						
5						
4						
3						
2						
1						
	A	B	C	D	E	F



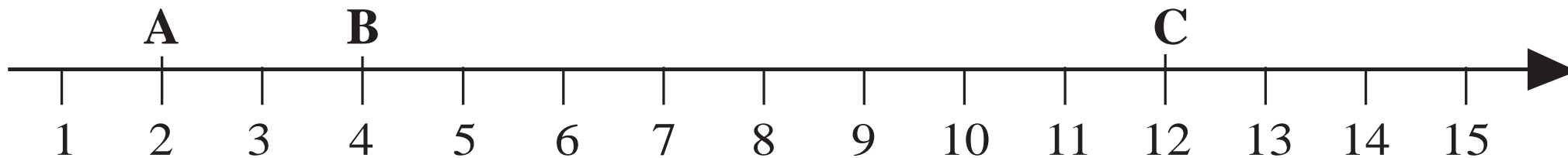

LP 161/3

---

1	2	3	4	5	6	7	8	9	10	11	12	13	14	15	16	17	18	19	20
21	22	23	24	25	26	27	28	29	30	31	32	33	34	35	36	37	38	39	40
41	42	43	44	45	46	47	48	49	50	51	52	53	54	55	56	57	58	59	60
61	62	63	64	65	66	67	68	69	70	71	72	73	74	75	76	77	78	79	80
81	82	83	84	85	86	87	88	89	90	91	92	93	94	95	96	97	98	99	100

LP 161/5

a)

	6	0	4	7
	5	9	2	8
+		3	1	4
<hr/>				

b)

	4	0	5	.	6
		3	9	.	2
+	1	0	0	.	7
<hr/>					

c)

	1	2	4	0	5
-		8	0	4	3
<hr/>					

d)

	5	9	.	2
-	1	3	.	7
<hr/>				
			.	

e)

	2	8	0	3
			×	6
<hr/>				

f)

	9	9	9
		×	9
<hr/>			

g)

8	1	5	3	6	2

h)

7	4	3	0	9

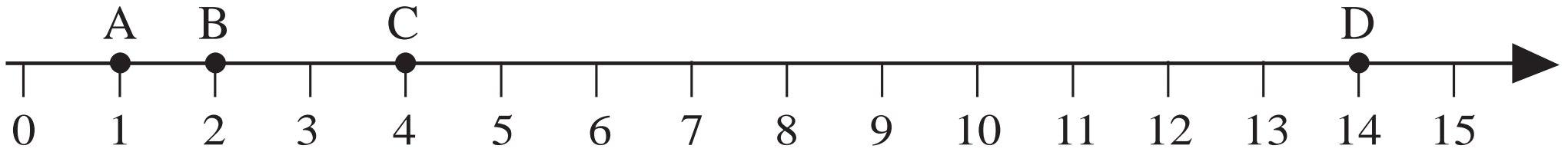

LP 162/2



LP 162/6

a)  $2756 - 1348 + 220 =$

$2756 - (1348 - 220) =$

b)  $2756 \times 4 + 1348 \times 4 =$

$(2756 + 1348) \times 4 =$

c)  $(6315 - 1726) \times 3 =$

$6315 \times 3 - 1726 \times 3 =$

d)  $10\ 256 \div 4 - 2372 \div 4 =$

$(10\ 256 - 2372) \div 4 =$

e)  $2187 \div (9 \div 3) =$

$2187 \div 9 \div 3 =$

f)  $2187 \times 9 \div 3 =$

$2187 \times (9 \div 3) =$



	<i>On diagram</i>	<i>In real life</i>
Side <i>a</i>	mm	m
Side <i>b</i>	mm	m
Perimeter	mm	m
Area	mm <sup>2</sup>	m <sup>2</sup>

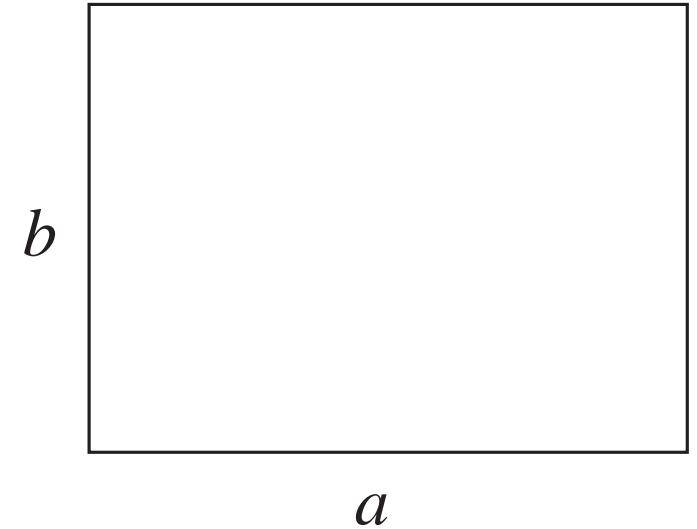

LP 164/3

	<i>On diagram</i>	<i>In real life</i>
Side <i>a</i>	mm	cm
Perimeter	mm	cm
Area	mm <sup>2</sup>	cm <sup>2</sup>

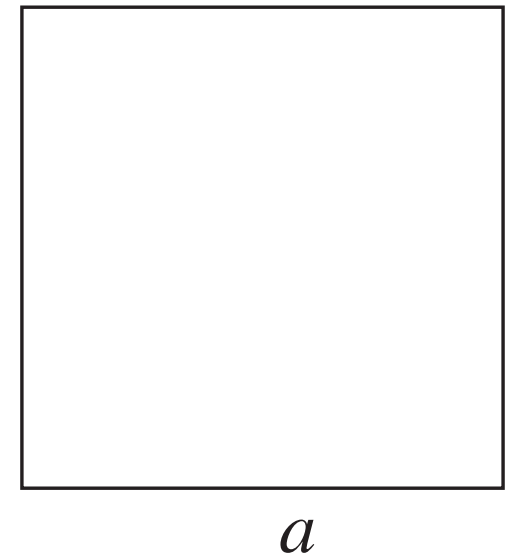

LP 164/4

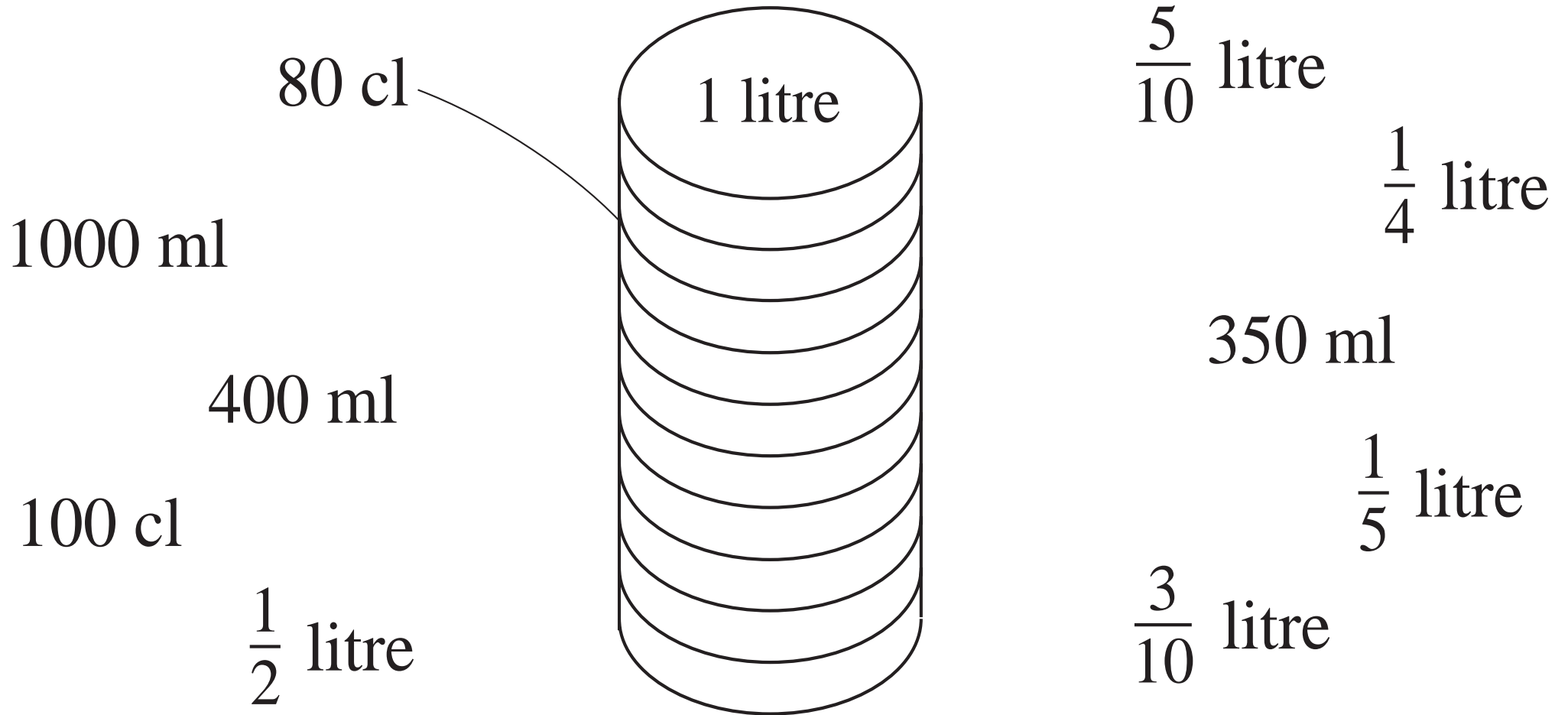

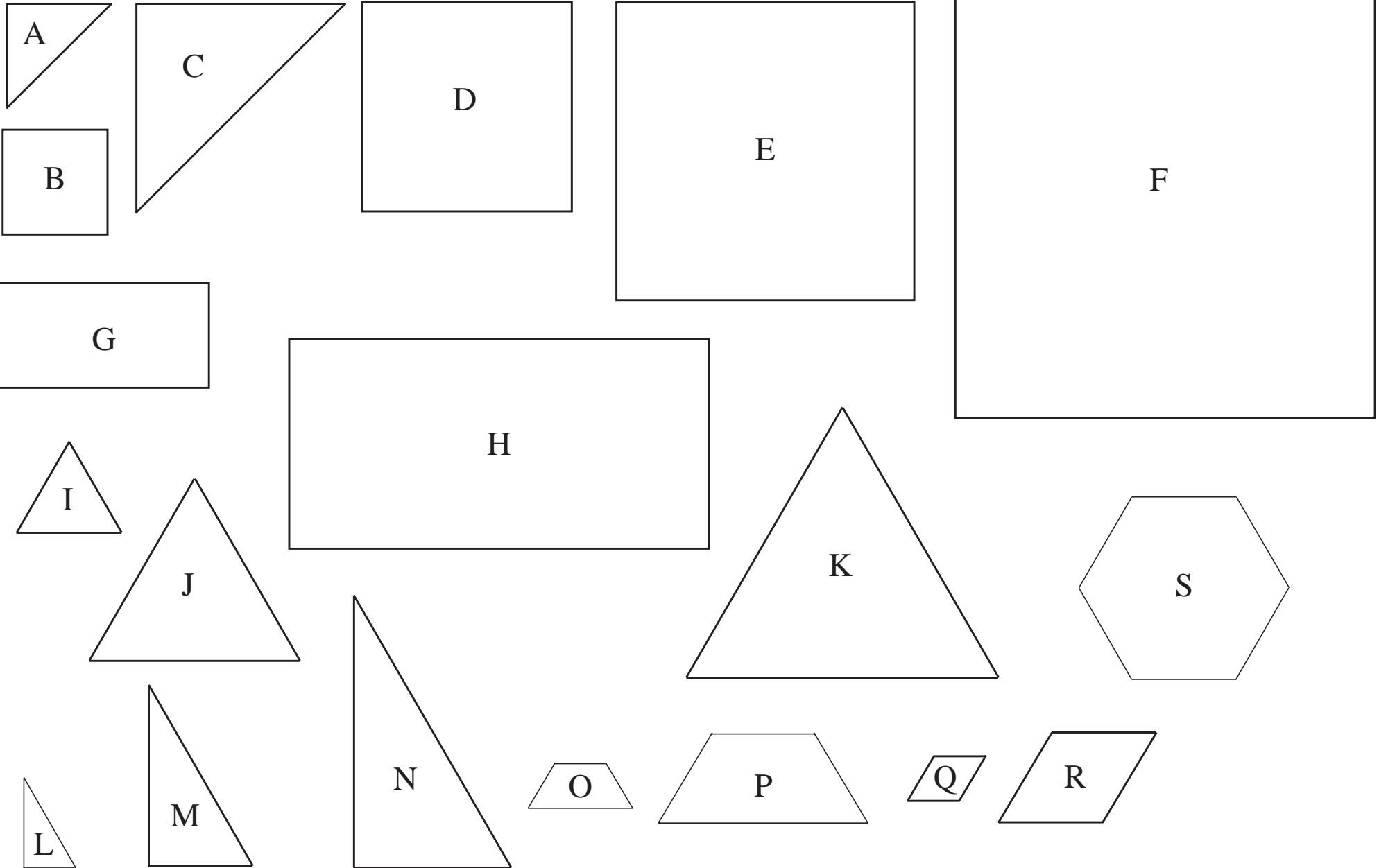



a)

$$\frac{1}{2}$$

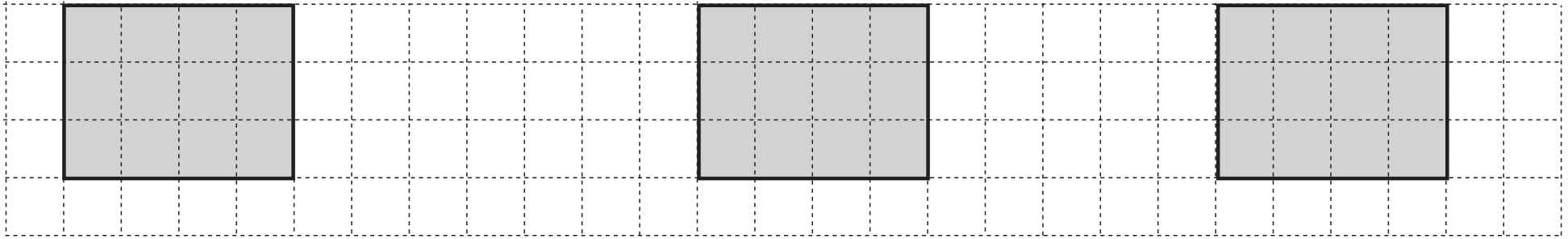

b)

$$\frac{2}{3}$$

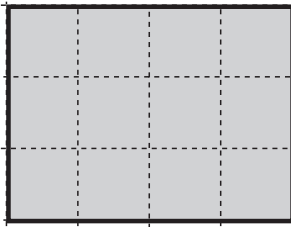

c)

$$\frac{3}{4}$$

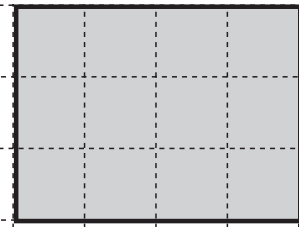

d)

$$\frac{1}{2}$$

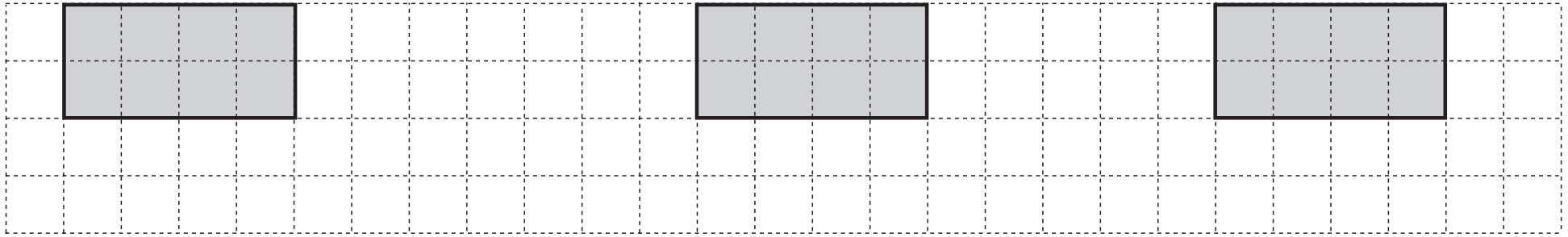

e)

$$\frac{4}{5}$$

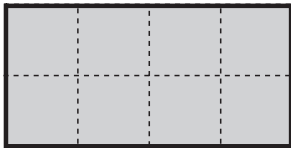

f)

$$\frac{8}{10}$$

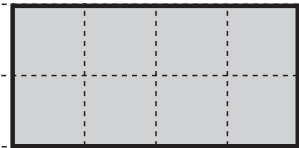

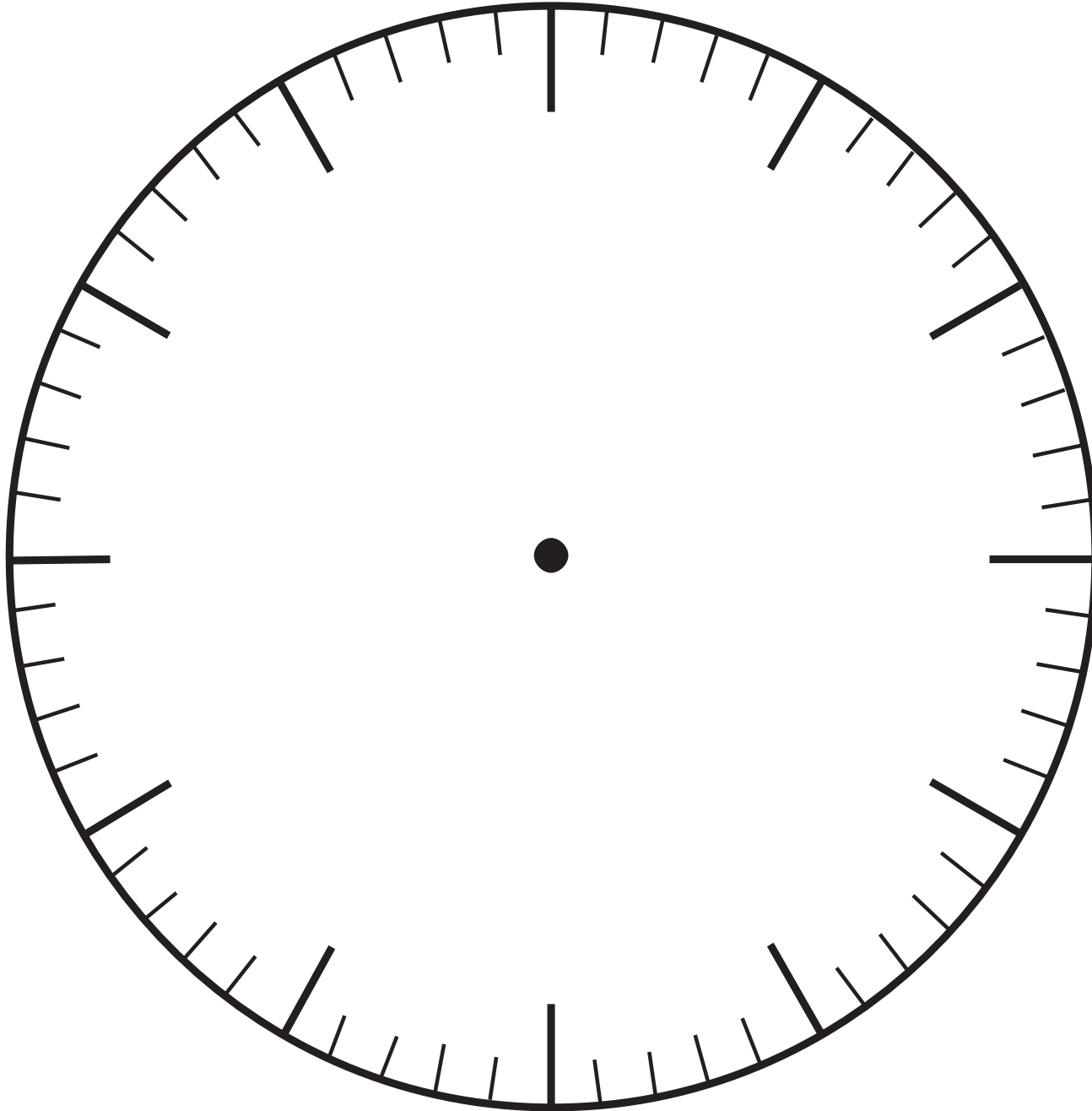

$$1 \text{ hour} = \boxed{\phantom{000}} \text{ minutes}$$

$$\text{a) } \frac{1}{4} \text{ hour} = \boxed{\phantom{000}} \text{ minutes} \quad \frac{3}{4} \text{ hour} = \boxed{\phantom{000}} \text{ minutes}$$

$$\text{b) } 0.5 \text{ hour} = \boxed{\phantom{000}} \text{ minutes} \quad 0.7 \text{ hour} = \boxed{\phantom{000}} \text{ minutes}$$

$$\text{c) } \frac{1}{3} \text{ hour} = \boxed{\phantom{000}} \text{ minutes} \quad \frac{2}{3} \text{ hour} = \boxed{\phantom{000}} \text{ minutes}$$

$$\text{d) } \frac{1}{6} \text{ hour} = \boxed{\phantom{000}} \text{ minutes} \quad \frac{5}{6} \text{ hour} = \boxed{\phantom{000}} \text{ minutes}$$

$$\text{e) } \frac{1}{5} \text{ hour} = \boxed{\phantom{000}} \text{ minutes} \quad 0.6 \text{ hour} = \boxed{\phantom{000}} \text{ minutes}$$



5, 25, 100,	1, 6, 21, 1201, 66,	2, 7, 42, 5317,	3, 8, 63, 4218,	4, 9, 99, 1644
----------------	------------------------	--------------------	--------------------	-------------------

10, 72, 38, 13, 54, 96, 61, 87, 75, 49,  
172, 359, 648, 975, 831, 570, 903, 184, 657



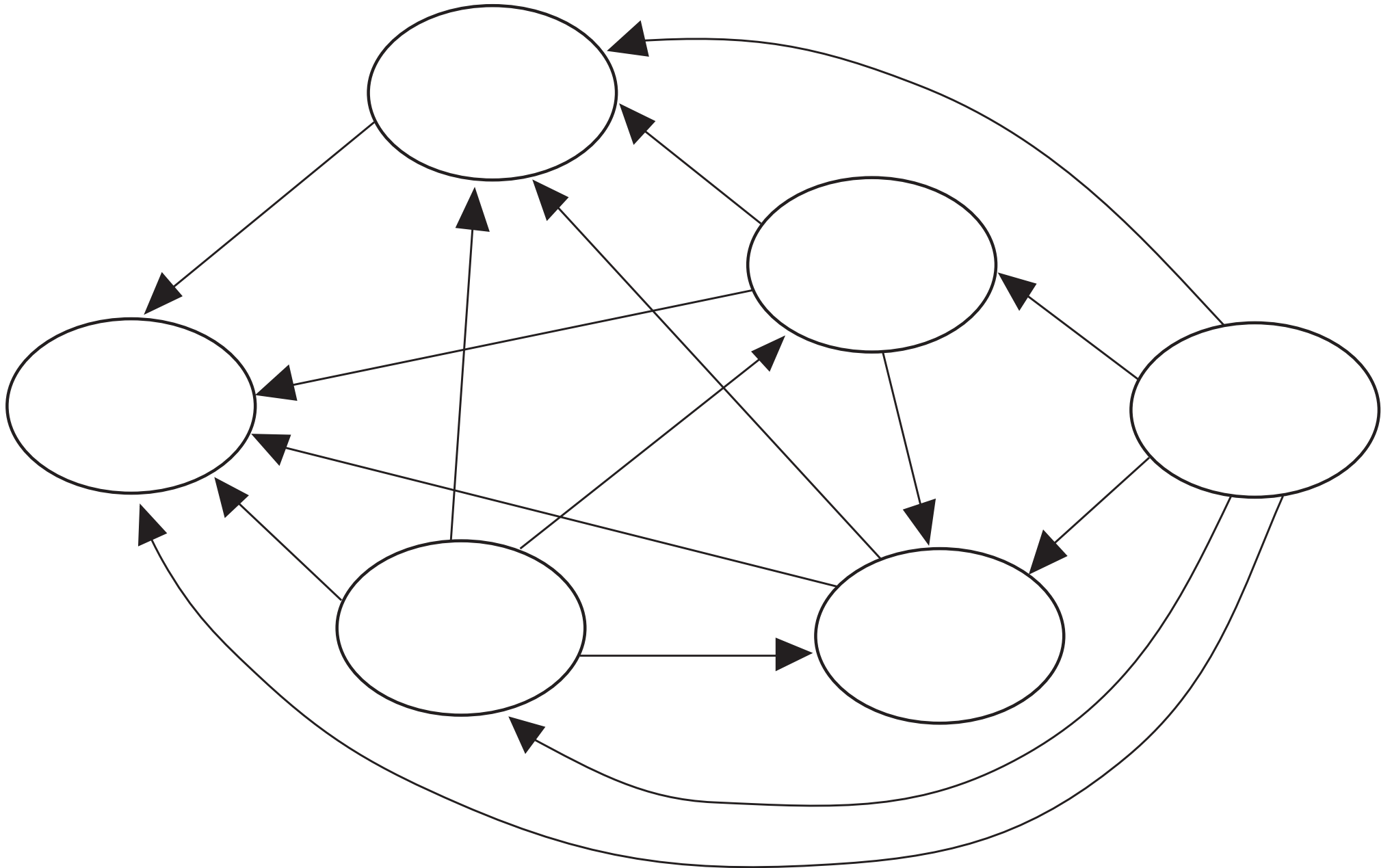

a)

A  
B  



b)

A  

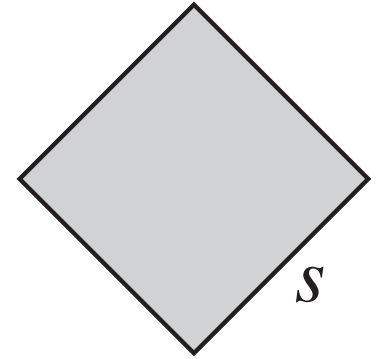

c)

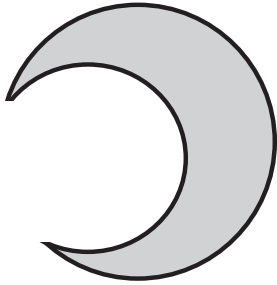
A  

d)

A  

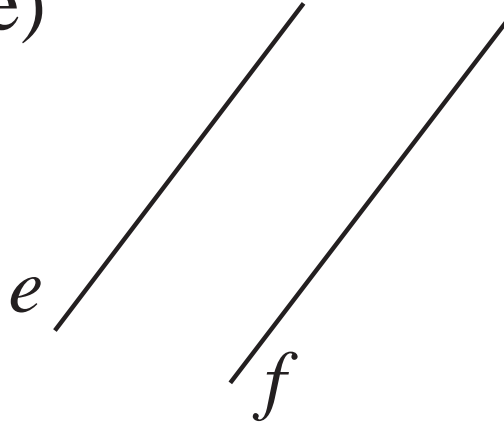
e)



f)

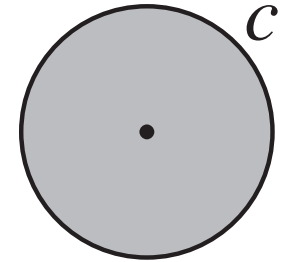

g)

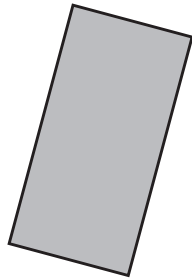
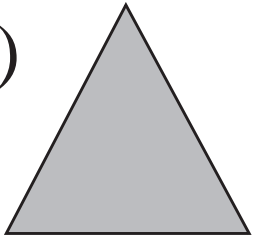

h)

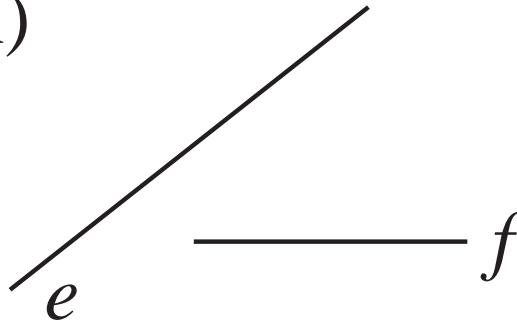

i)

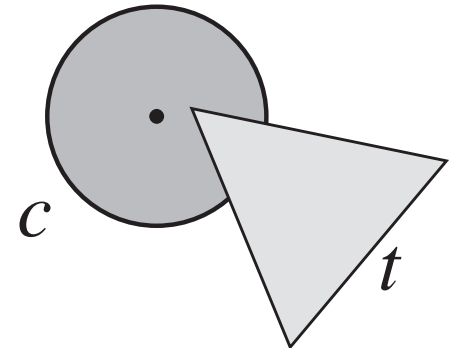

a)

1	2	4	3	5
+	3	0	7	2

b)

2	3	4	0	8	
−	1	0	5	0	7

c)

	8	2	5	3
			×	8

d)

6	2	8	2	1	8

e)

1	0	9	5	6
			×	7

f)

8	7	4	3	0	
−	2	3	5	1	0

g)

2	6	1	0	0
			×	3

h)

9	8	7	9	0	3



*Bread*

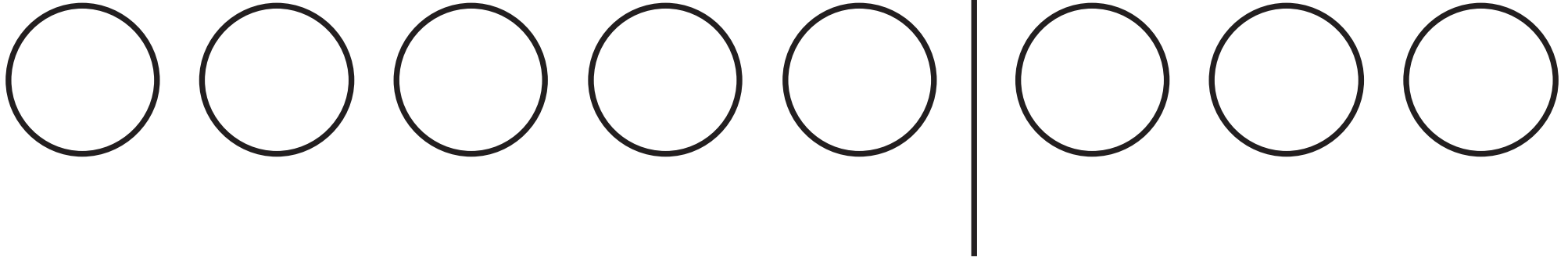

*Coins*

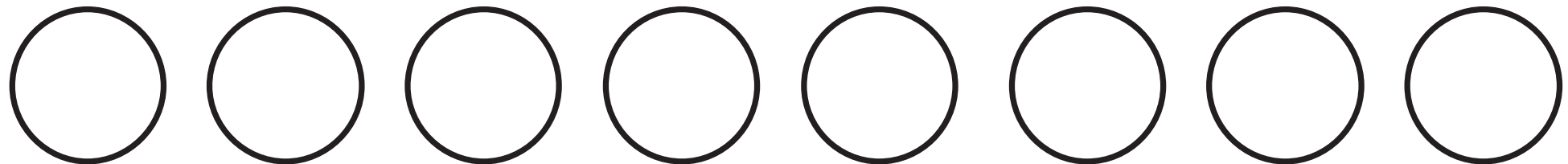

a)

		5	8	7
	5	3	4	2
+	7	7	9	3
<hr/>				

b)

8	0	4	3	2
-	5	6	7	9
<hr/>				

c)

	3	5	2	8
			×	5
<hr/>				

d)

9	8	1	2	8	8

h)

4	1	0	1	0	4

e)

	6	5	9	0
			×	8
<hr/>				

f)

	3	4	7	0	8
-	1	0	5	3	2
<hr/>					

g)

1	4	0	3	5
			×	7
<hr/>				

i)

1	1	6	7	3	2

*Set A* = {11, 7, 14, 23, 1, 25, 49, 70, 15, 45, 3, 100, 47, 19, 2}

A

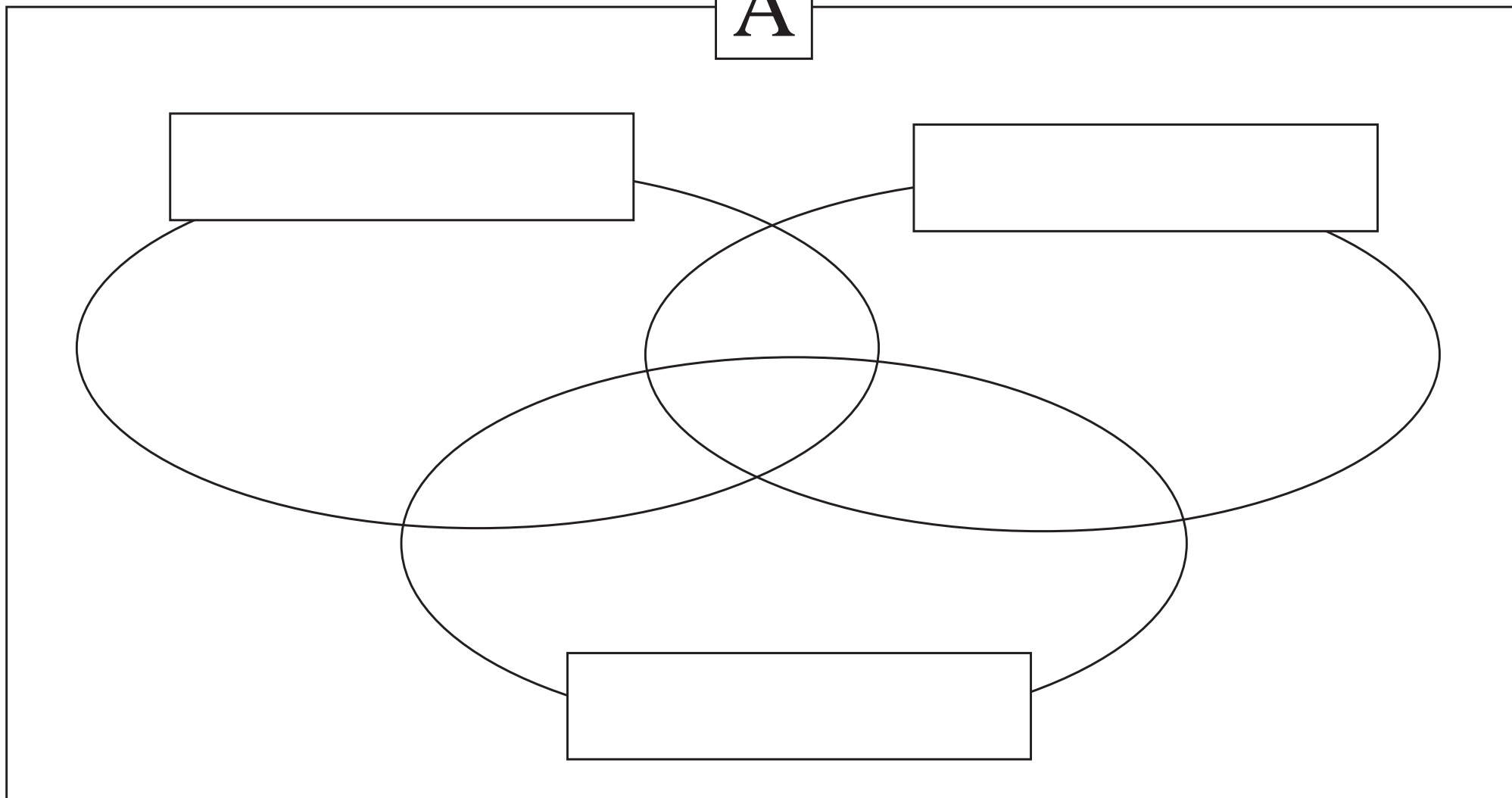

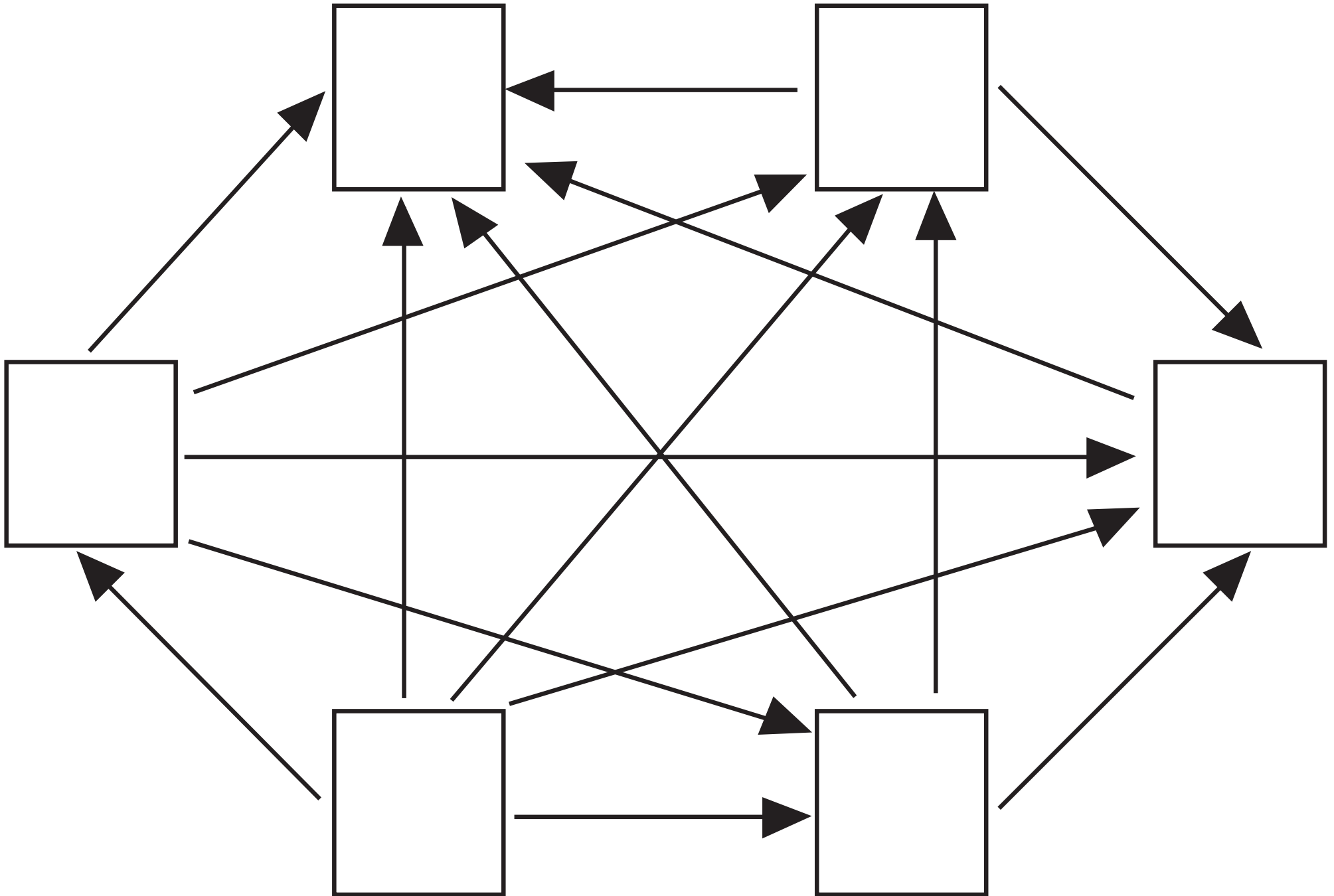

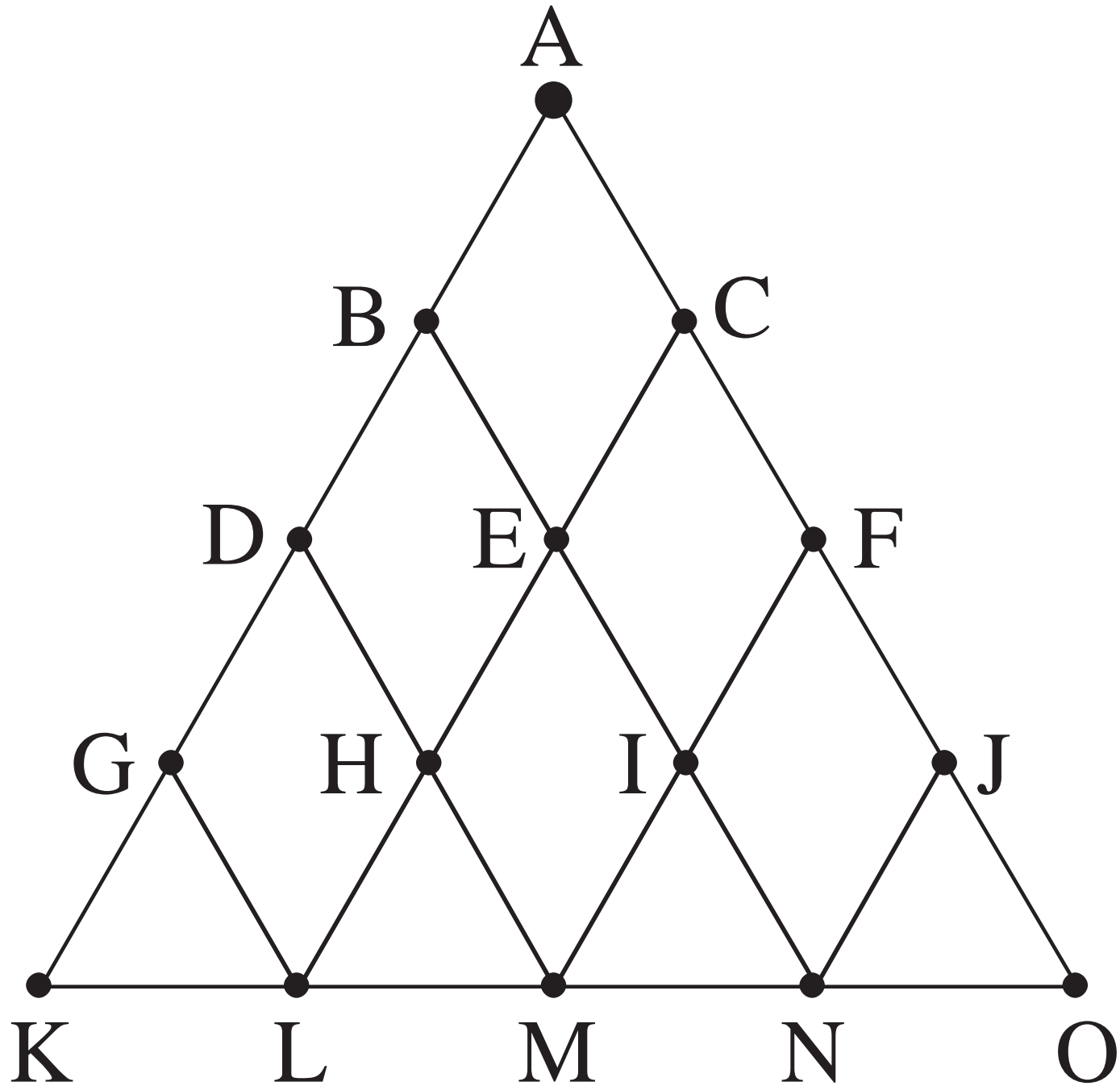

4000	2900	3500	1700	2800	1700
3100	2600	5100	2000	4300	4200
4400	2700	9300	1000	1200	5800
3500	1400	2300	2600	2800	3900





- a) 4200, 4000, 5200,  
5400, 5600, 5800

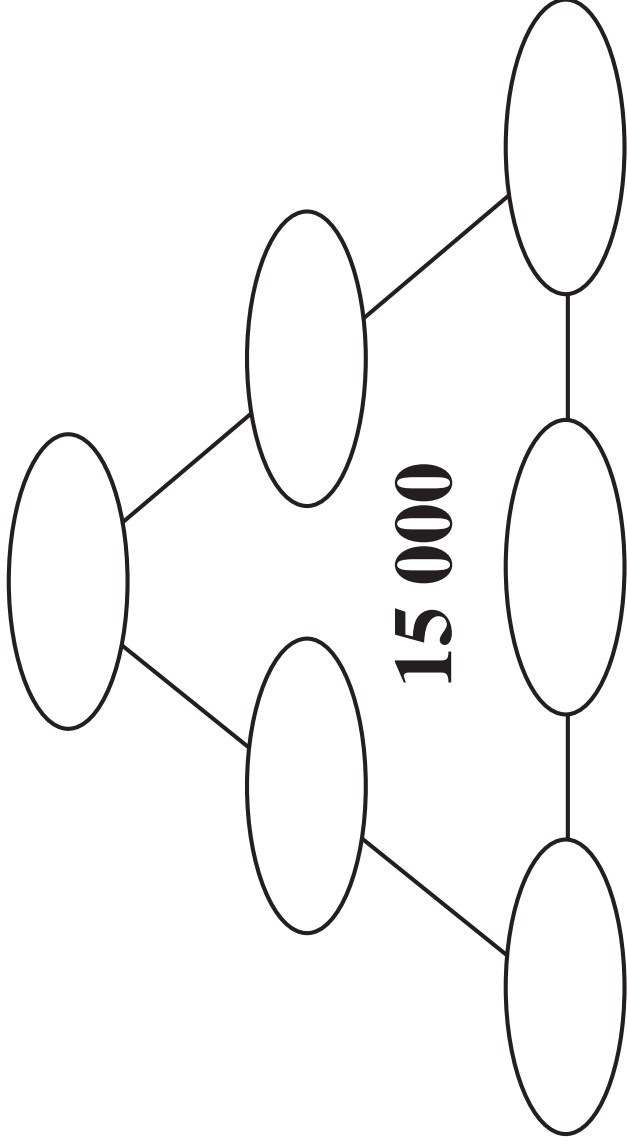

- b) 5400, 5600, 5800, 4800,  
5000, 5200, 4000, 4600

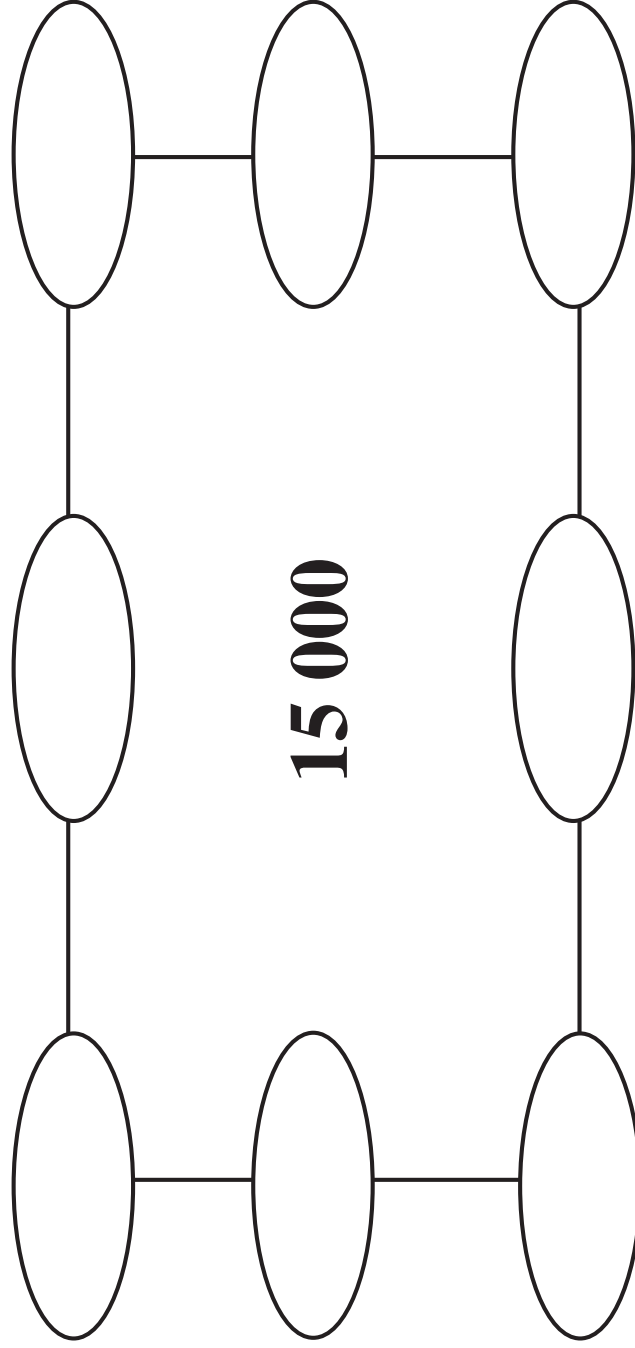

a)

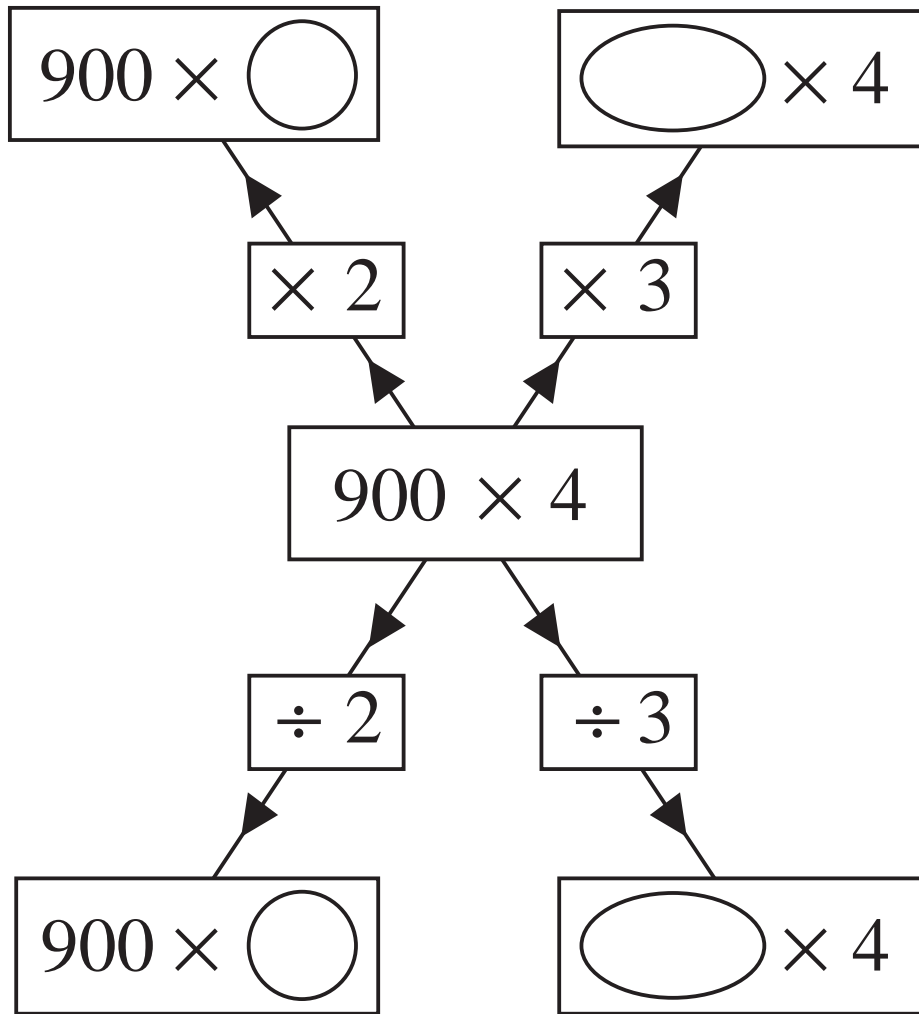

b)

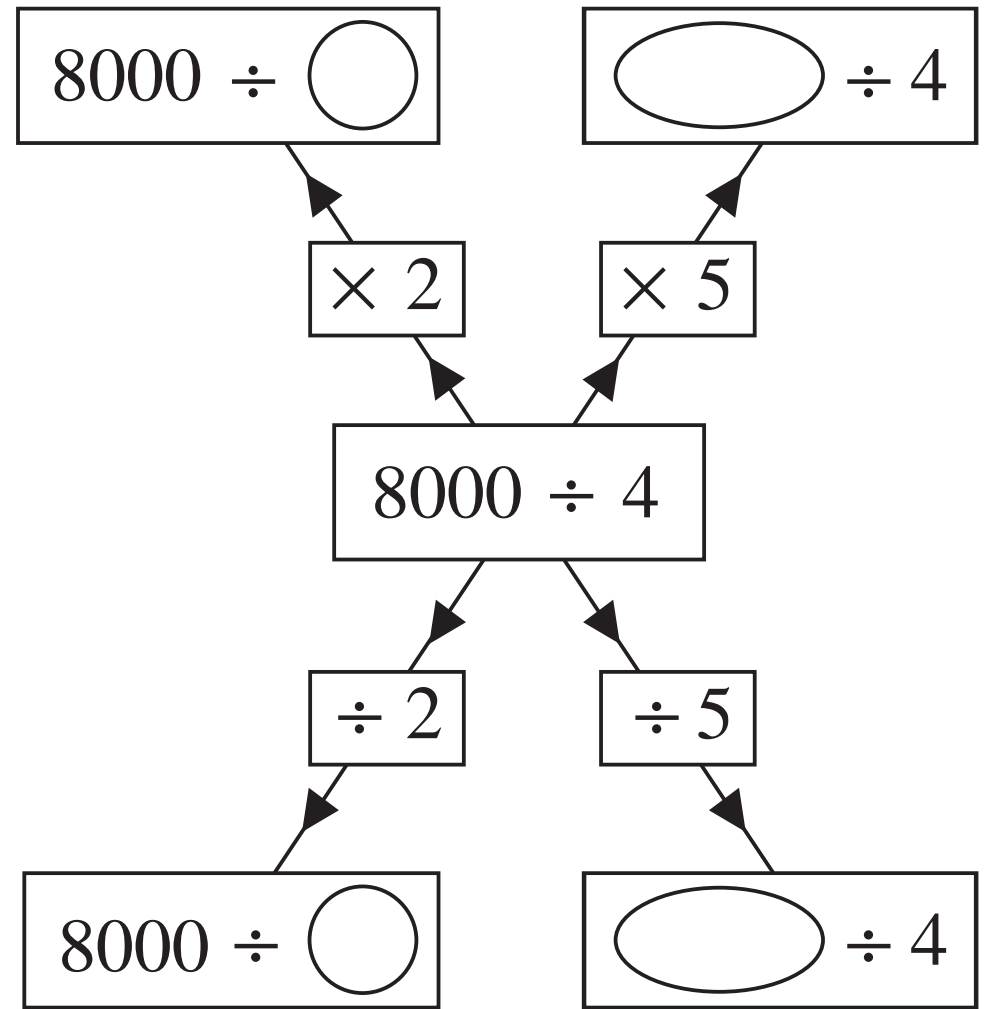



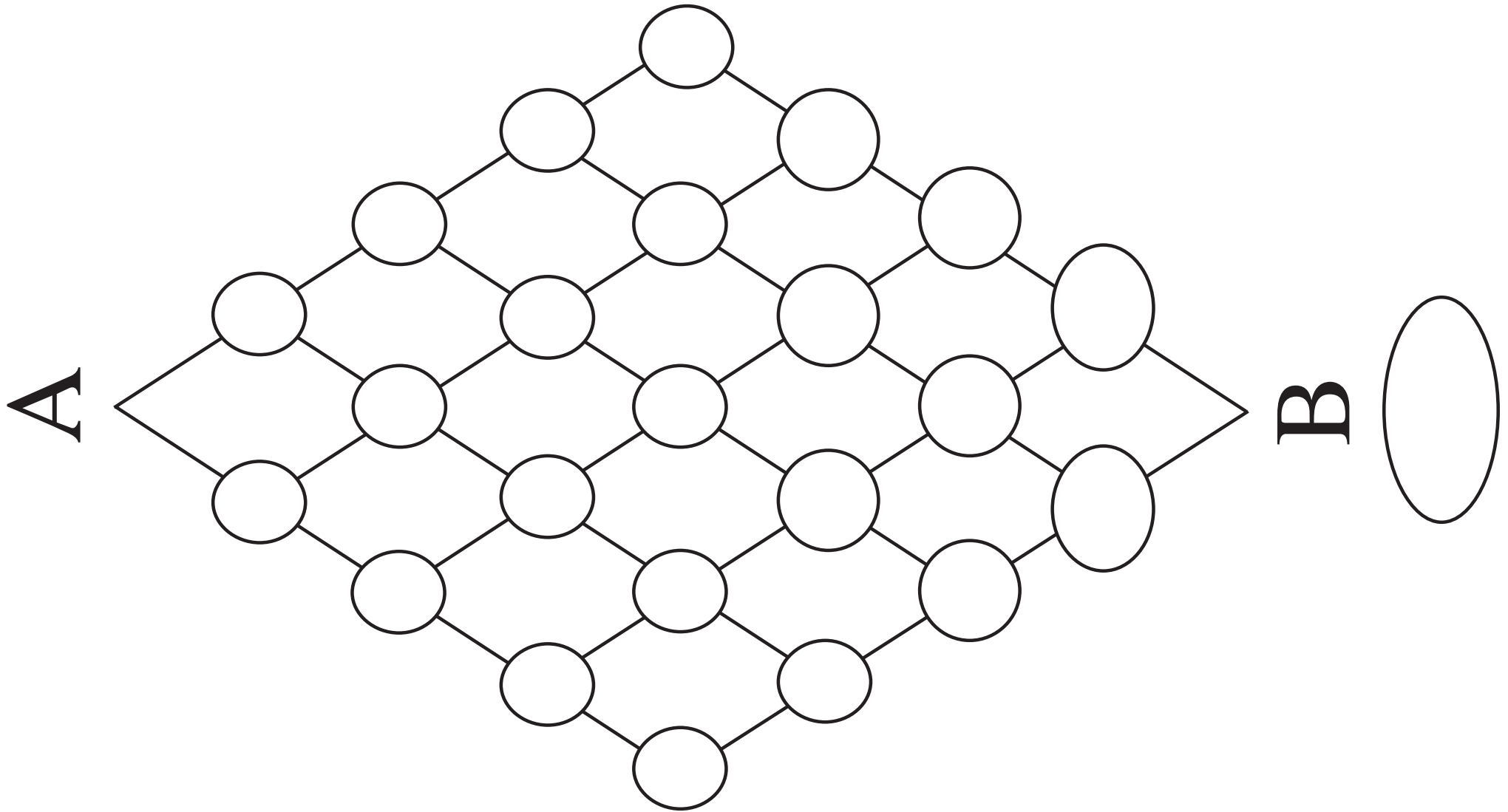

$$1 \leq n \leq 18$$

A

B

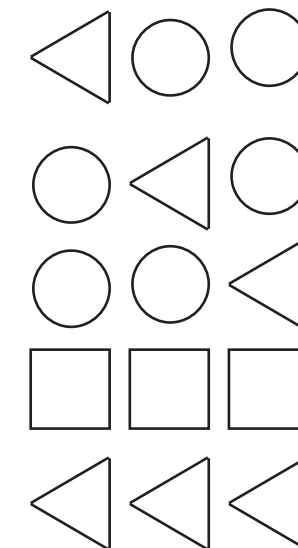
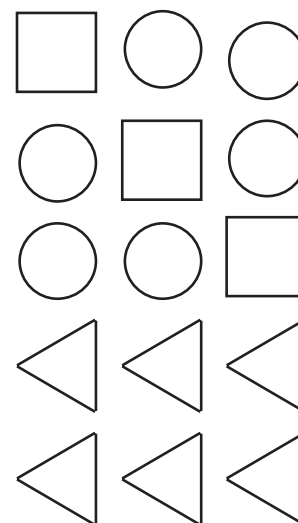
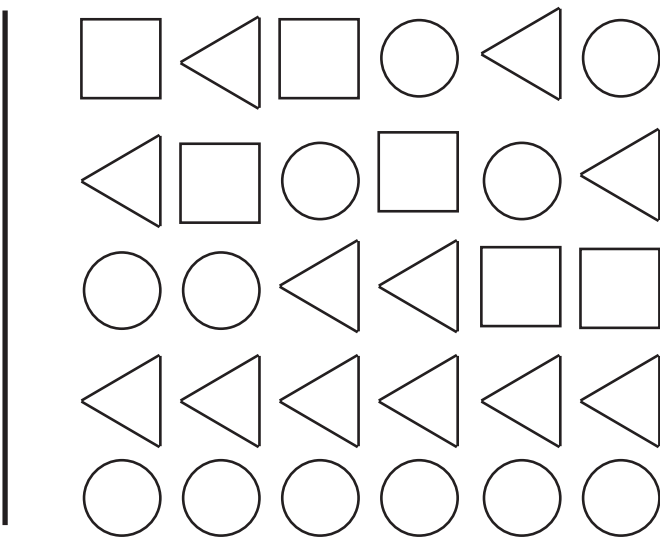
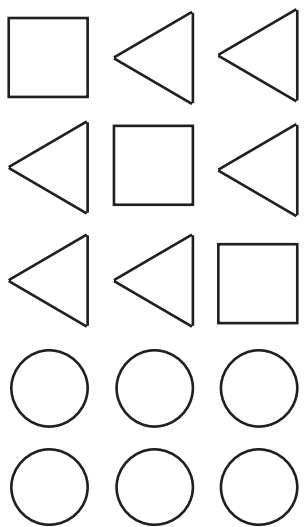
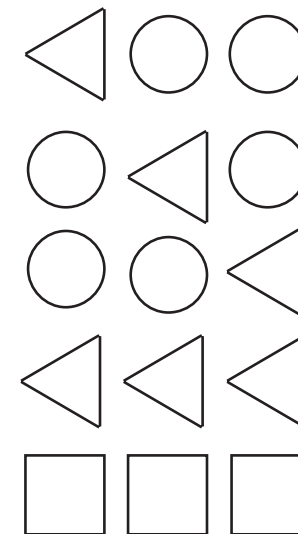
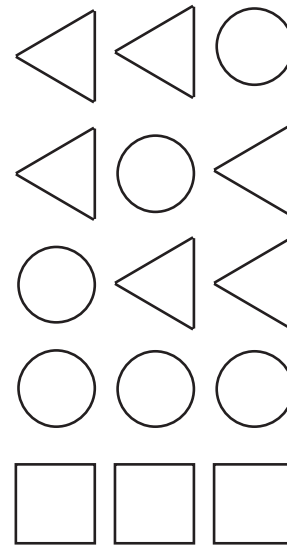
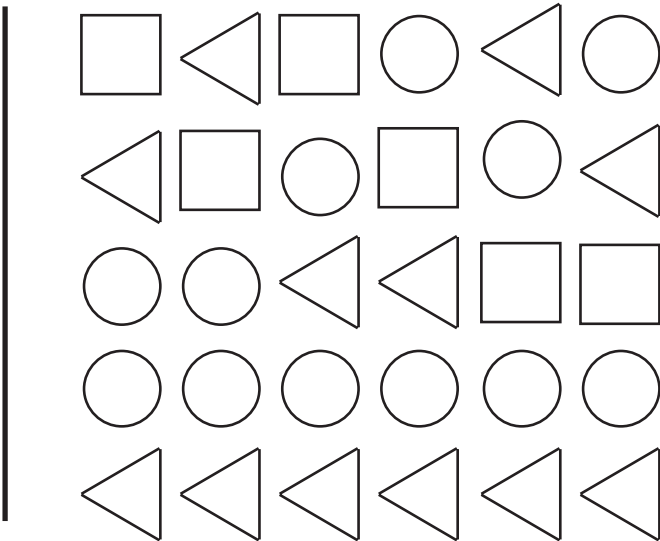
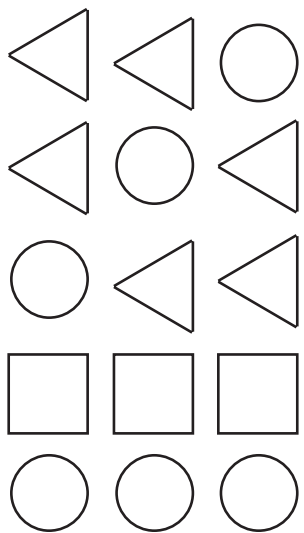

1. On this sheet there is exactly one false statement.
2. On this sheet there are exactly two false statements.
3. On this sheet there are exactly three false statements.
4. On this sheet there are exactly four false statements.

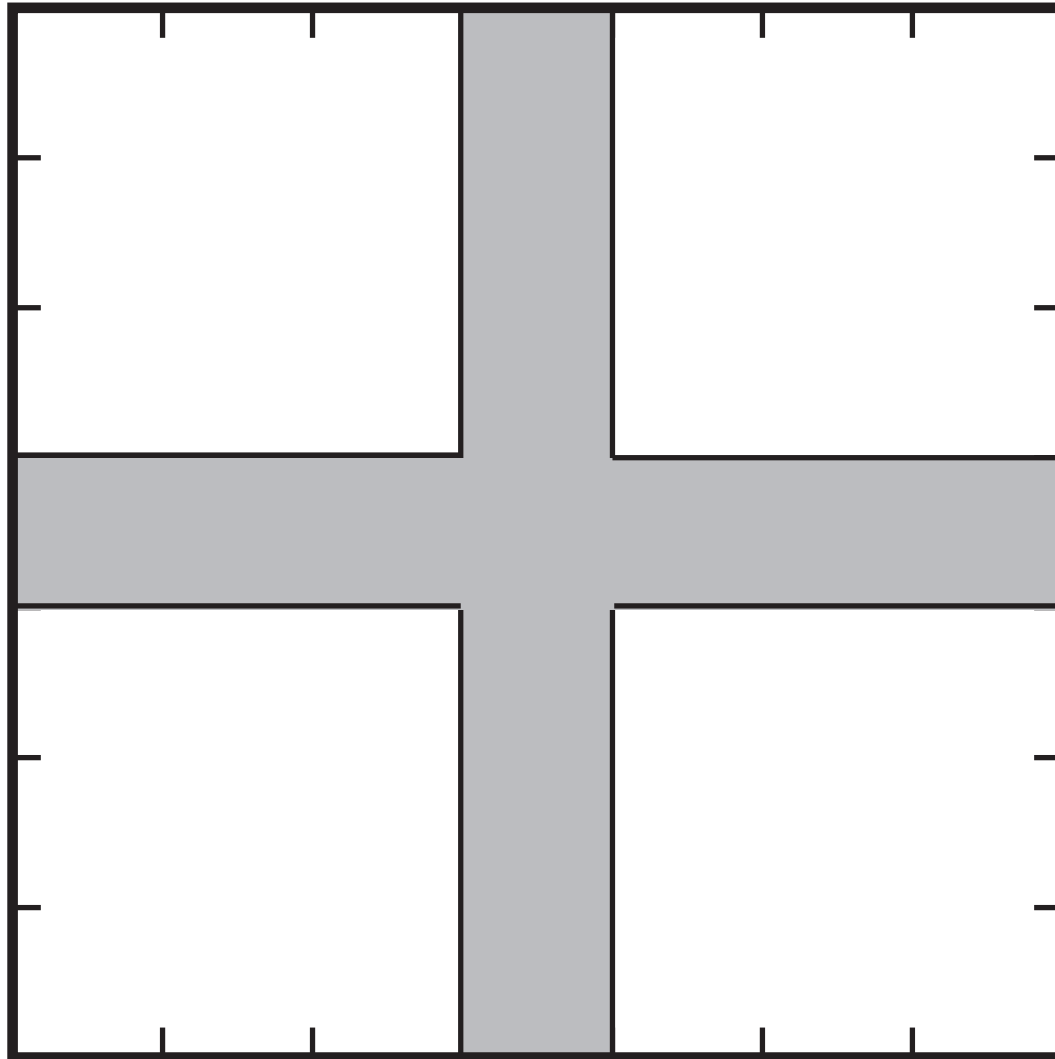

## Horizontal Clues

**a**  $7032 - 3768$

**f**  $4773 + 2789$

**g** The 9th square number

**h**  $56Th + 7H + 5T + 3U$

**j**  $518 \times 4$

**l** Difference between the smallest 3-digit number and the smallest natural number

a	b	c	d		e
f					
				gg	
h			i		
		j			k
l					

## Vertical Clues

**a**  $18975 \div 5$

**b** 1 quarter of 100

**c**  $65\ 000 + 1872$

**d**  $\left(\frac{2}{5} \text{ of } 15\right) \times (140 \div 20)$

**e** A 3-digit number with all its digits the same

**g**  $10\ 000 - 9163$

**i**  $\frac{1}{4} \text{ of } 2000 + 4 \times \frac{1}{4}$

**k** The 10th prime number

## Horizontal clues only

- 1 6-sided plane shape
- 2 3-D shape with many plane faces
- 3 To make bigger
- 4 Plane shape with no straight sides
- 5 Opposite of multiply
- 6 A triangle has 3 of them
- 7 A shape has this if one half is a mirror image of the other half
- 8 The same shape but not necessarily the same size

